

SENSAPHONE[®] *Express*



User's Manual



Phonetics, Inc.

Every effort has been made to ensure that the information in this document is complete, accurate and up-to-date. PHONETICS, INC. assumes no responsibility for the results of errors beyond its control. PHONETICS, INC. also cannot guarantee that changes in equipment made by other manufacturers, and referred to in this manual, will not affect the applicability of the information in this manual.

Copyright © 1995 by Phonetics, Inc., d.b.a. Sensaphone

Third Edition, version 1.61, November 2004.

Written and produced by Phonetics, Inc.

Please address comments on this publication to:

PHONETICS, INC.
901 Tryens Road
Aston, PA 19014
www.sensaphone.com

Sensaphone® is a registered trademark of Phonetics, Inc.

Touch Tone™ is a registered trademark of AT&T.

IMPORTANT SAFETY INSTRUCTIONS

Your Sensaphone Express has been carefully designed to give you years of safe, reliable performance. As with all electrical equipment, however, there are a few basic precautions you should take to avoid hurting yourself or damaging the unit:

- Read the installation and operating instructions in this manual carefully. Be sure to save it for future reference.
- Read and follow all warning and instruction labels on the product itself.
- To protect the unit from overheating, make sure all openings on the unit are not blocked. Do not place on or near a heat source, such as a radiator or heat register.
- Do not use your unit near water, or spill liquid of any kind into it.
- Be certain that your power source matches the rating listed on the AC power transformer. If you're not sure of the type of power supply to your facility, consult your dealer or local power company.
- Do not allow anything to rest on the power cord. Do not locate this product where the cord will be abused by persons walking on it.
- Do not overload wall outlets and extension cords, as this can result in the risk of fire or electric shock.
- Never push objects of any kind into this product through ventilation holes as they may touch dangerous voltage points or short out parts that could result in a risk of fire or electric shock.
- To reduce the risk of electric shock, do not disassemble this product, but return it to Sensaphone Technical Service, or other approved repair facility, when any service or repair work is required. Opening or removing covers may expose you to dangerous voltages or other risks. Incorrect reassembly can cause electric shock when the unit is subsequently used.
- If anything happens that indicates that your unit is not working properly or has been damaged, unplug it immediately and follow the procedures in Appendix C for having it serviced.

Return the unit for servicing under the following conditions:

1. The power cord or plug is frayed or damaged.
 2. Liquid has been spilled into the product or it has been exposed to water.
 3. The unit has been dropped, or the cabinet is damaged.
 4. The unit doesn't function normally when you're following the operating instructions.
- Avoid using a telephone (other than a cordless type) during an electrical storm. There may be a remote risk of electric shock from lightning.
 - Do not use the telephone to report a gas leak in the vicinity of the leak.

CAUTION

TO REDUCE THE RISK OF FIRE OR INJURY TO PERSONS, READ AND FOLLOW THESE INSTRUCTIONS:

1. Use only the following type and size battery: Sealed lead-acid 12V 1.9 - 2.2AH.
2. Do not dispose of the battery in a fire. The cell may explode. Check with local codes for possible special disposal instructions.
3. Do not open or mutilate the battery. Released electrolyte is corrosive and may cause damage to the eyes or skin. It may be toxic if swallowed.
4. Exercise care in handling the battery in order not to short the battery with conducting materials such as rings, bracelets, and keys. The battery or conductor may overheat and cause burns.

1 YEAR LIMITED WARRANTY

PLEASE READ THIS WARRANTY CAREFULLY BEFORE USING THE PRODUCT.

THIS LIMITED WARRANTY CONTAINS SENSAPHONE'S STANDARD TERMS AND CONDITIONS. WHERE PERMITTED BY THE APPLICABLE LAW, BY KEEPING YOUR SENSAPHONE PRODUCT BEYOND THIRTY (30) DAYS AFTER THE DATE OF DELIVERY, YOU FULLY ACCEPT THE TERMS AND CONDITIONS SET FORTH IN THIS LIMITED WARRANTY.

IN ADDITION, WHERE PERMITTED BY THE APPLICABLE LAW, YOUR INSTALLATION AND/OR USE OF THE PRODUCT CONSTITUTES FULL ACCEPTANCE OF THE TERMS AND CONDITIONS OF THIS LIMITED WARRANTY (HEREINAFTER REFERRED TO AS "LIMITED WARRANTY OR WARRANTY"). IF YOU DO NOT AGREE TO THE TERMS AND CONDITIONS OF THIS WARRANTY, INCLUDING ANY LIMITATIONS OF WARRANTY, INDEMNIFICATION TERMS OR LIMITATION OF LIABILITY, THEN YOU SHOULD NOT USE THE PRODUCT AND SHOULD RETURN IT TO THE SELLER FOR A REFUND OF THE PURCHASE PRICE. THE LAW MAY VARY BY JURISDICTION AS TO THE APPLICABILITY OF YOUR INSTALLATION OR USE ACTUALLY CONSTITUTING ACCEPTANCE OF THE TERMS AND CONDITIONS HEREIN AND AS TO THE APPLICABILITY OF ANY LIMITATION OF WARRANTY, INDEMNIFICATION TERMS OR LIMITATIONS OF LIABILITY.

1. **WARRANTOR:** In this Warranty, Warrantor shall mean "Dealer, Distributor, and/or Manufacturer."

2. **ELEMENTS OF WARRANTY:** This Product is warranted to be free from defects in materials and craftsmanship with only the limitations and exclusions set out below.

3. **WARRANTY AND REMEDY:** One-Year Warranty — In the event that the Product does not conform to this warranty at any time during the time of one year from original purchase, warrantor will repair the defect and return it to you at no charge.

This warranty shall terminate and be of no further effect at the time the product is: (1) damaged by extraneous cause such as fire, water, lightning, etc. or not maintained as reasonable and necessary; or (2) modified; or (3) improperly installed; or (4) misused; or (5) repaired or serviced by someone other than Warrantors' authorized personnel or someone expressly authorized by Warrantor's to make such service or repairs; (6) used in a manner or purpose for which the product was not intended; or (7) sold by original purchaser.

LIMITED WARRANTY, LIMITATION OF DAMAGES AND DISCLAIMER OF LIABILITY FOR DAMAGES: THE WARRANTOR'S OBLIGATION UNDER THIS WARRANTY IS LIMITED TO REPAIR OR REPLACEMENT OF THE PRODUCT, AT THE WARRANTOR'S OPTION AS TO REPAIR OR REPLACEMENT. IN NO

EVENT SHALL WARRANTORS BE LIABLE OR RESPONSIBLE FOR PAYMENT OF ANY INCIDENTAL, CONSEQUENTIAL, SPECIAL AND/OR PUNITIVE DAMAGES OF ANY KIND, INCLUDING BUT NOT LIMITED TO ANY LABOR COSTS, PRODUCT COSTS, LOST REVENUE, BUSINESS INTERRUPTION LOSSES, LOST PROFITS, LOSS OF BUSINESS, LOSS OF DATA OR INFORMATION, OR FINANCIAL LOSS, FOR CLAIMS OF ANY NATURE, INCLUDING BUT NOT LIMITED TO CLAIMS IN CONTRACT, BREACH OF WARRANTY OR TORT, AND WHETHER OR NOT CAUSED BY WARRANTORS' NEGLIGENCE. IN THE EVENT THAT IT IS DETERMINED IN ANY ADJUDICATION THAT THE LIMITED WARRANTIES OF REPAIR OR REPLACEMENT ARE INAPPLICABLE, THEN THE PURCHASER'S SOLE REMEDY SHALL BE PAYMENT TO THE PURCHASER OF THE ORIGINAL COST OF THE PRODUCT, AND IN NO EVENT SHALL WARRANTORS BE LIABLE OR RESPONSIBLE FOR PAYMENT OF ANY INCIDENTAL, CONSEQUENTIAL, SPECIAL AND/OR PUNITIVE DAMAGES OF ANY KIND, INCLUDING BUT NOT LIMITED TO ANY LOST REVENUE, BUSINESS INTERRUPTION LOSSES, LOST PROFITS, LOSS OF BUSINESS, LOSS OF DATA OR INFORMATION, OR FINANCIAL LOSS, FOR CLAIMS OF ANY NATURE, INCLUDING BUT NOT LIMITED TO CLAIMS IN CONTRACT, BREACH OF WARRANTY OR TORT, AND WHETHER OR NOT CAUSED BY WARRANTORS' NEGLIGENCE.

WITHOUT WAIVING ANY PROVISION IN THIS LIMITED WARRANTY, IF A CIRCUMSTANCE ARISES WHERE WARRANTORS ARE FOUND TO BE LIABLE FOR ANY LOSS OR DAMAGE ARISING OUT OF MISTAKES, NEGLIGENCE, OMISSIONS, INTERRUPTIONS, DELAYS, ERRORS OR DEFECTS IN WARRANTORS' PRODUCTS OR SERVICES, SUCH LIABILITY SHALL NOT EXCEED THE TOTAL AMOUNT PAID BY THE CUSTOMER FOR WARRANTORS' PRODUCT AND SERVICES OR \$250.00, WHICHEVER IS GREATER. YOU HEREBY RELEASE WARRANTORS FROM ANY AND ALL OBLIGATIONS, LIABILITIES AND CLAIMS IN EXCESS OF THIS LIMITATION.

INDEMNIFICATION AND COVENANT NOT TO SUE: YOU WILL INDEMNIFY, DEFEND AND HOLD HARMLESS WARRANTORS, THEIR OWNERS, DIRECTORS, OFFICERS, EMPLOYEES, AGENTS, SUPPLIERS OR AFFILIATED COMPANIES, AGAINST ANY AND ALL CLAIMS, DEMANDS OR ACTIONS BASED UPON ANY LOSSES, LIABILITIES, DAMAGES OR COSTS, INCLUDING BUT NOT LIMITED TO DAMAGES THAT ARE DIRECT OR INDIRECT, INCIDENTAL, SPECIAL OR CONSEQUENTIAL, AND INCLUDING ATTORNEYS FEES AND LEGAL COSTS, THAT MAY RESULT FROM THE INSTALLATION, OPERATION, USE OF, OR INABILITY TO USE WARRANTORS' PRODUCTS AND SERVICES, OR FROM THE FAILURE OF THE WARRANTORS' SYSTEM TO REPORT A GIVEN EVENT OR CONDITION, WHETHER OR NOT CAUSED BY WARRANTORS' NEGLIGENCE.

YOU AGREE TO RELEASE, WAIVE, DISCHARGE AND COVENANT NOT TO SUE WARRANTORS, THEIR OWNERS, DIRECTORS, OFFICERS, EMPLOYEES, AGENTS, SUPPLIERS OR AFFILIATED COMPANIES, FOR ANY AND ALL LIABILITIES POTENTIALLY ARISING FROM ANY CLAIM, DEMAND OR ACTION BASED UPON ANY LOSSES, LIABILITIES, DAMAGES OR COSTS,

INCLUDING BUT NOT LIMITED TO DAMAGES THAT ARE DIRECT OR INDIRECT, INCIDENTAL, SPECIAL OR CONSEQUENTIAL, AND INCLUDING ATTORNEYS FEES AND LEGAL COSTS, THAT MAY RESULT FROM THE INSTALLATION, OPERATION, USE OF, OR INABILITY TO USE WARRANTORS' PRODUCTS AND SERVICES, OR FROM THE FAILURE OF THE WARRANTORS' SYSTEM TO REPORT A GIVEN EVENT OR CONDITION, WHETHER OR NOT CAUSED BY WARRANTORS' NEGLIGENCE, EXCEPT AS NECESSARY TO ENFORCE THE EXPRESS TERMS OF THIS LIMITED WARRANTY.

EXCLUSIVE WARRANTY: THE LIMITED WARRANTY OR WARRANTIES DESCRIBED HEREIN CONSTITUTE THE SOLE WARRANTY OR WARRANTIES TO THE PURCHASER. ALL IMPLIED WARRANTIES ARE EXPRESSLY DISCLAIMED, INCLUDING: THE WARRANTY OF MERCHANTABILITY AND THE WARRANTY OF FITNESS FOR A PARTICULAR USE AND THE WARRANTY OF FITNESS FOR A PARTICULAR PURPOSE AND THE WARRANTY OF NON-INFRINGEMENT AND/OR ANY WARRANTY ARISING FROM A COURSE OF DEALING, USAGE, OR TRADE PRACTICE.

It must be clear that the Warrantors are not insuring your premises or business or guaranteeing that there will not be damage to your person or property or business if you use this Product. You should maintain insurance coverage sufficient to provide compensation for any loss, damage, or expense that may arise in connection with the use of products or services, even if caused by Warrantors' negligence. The warrantors assume no liability for installation of the Product and/or interruptions of the service due to strikes, riots, floods, fire, and/or any cause beyond Seller's control, further subject to the limitations expressed in any License Agreement or other Agreement provided by Warrantors to purchaser.

The agreement between the Warrantors and the Purchaser, including but not limited to the terms and conditions herein shall not be governed by the Convention for the International Sale of Goods. Where applicable, the Uniform Commercial Code as adopted by the State of Delaware shall apply.

4. PROCEDURE FOR OBTAINING PERFORMANCE OF WARRANTY: In the event that the Product does not conform to this warranty, the Product should be shipped or delivered freight prepaid to a Warrantor with evidence of original purchase.

5. LEGAL REMEDIES AND DISCLAIMER: Some jurisdictions may not allow, or may place limits upon, the exclusion and/or limitation of implied warranties, incidental damages and/or consequential damages for some types of goods or products sold to consumers and/or the use of indemnification terms. Thus, the exclusions, indemnification terms and limitations set out above may not apply, or may be limited in their application, to you. If the implied warranties can not be excluded, and the applicable law permits limiting the duration of implied war-

warranties, then the implied warranties herein are to be limited to the same duration as the applicable written warranty or warranties herein. The warranty or warranties herein may give you specific legal rights that will depend upon the applicable law. You may also have other legal rights depending upon the law in your jurisdiction.

6. CHOICE OF FORUM AND CHOICE OF LAW: In the event that a dispute arises out of or in connection with this Limited Warranty, then any claims or suits of any kind concerning such disputes shall only and exclusively be brought in either the Court of Common Pleas of Delaware County, Pennsylvania or the United States District Court for the Eastern District of Pennsylvania.

Regardless of the place of contracting or performance, this Limited Warranty and all questions relating to its validity, interpretation, performance and enforcement shall be governed by and construed in accordance with the laws of the State of Delaware, without regard to the principles of conflicts of law.

Effective date 05/01/2004
PHONETICS, INC. d.b.a. SENSAPHONE
901 Tryens Road
Aston, PA 19014
Phone: 610.558.2700 Fax: 610.558.0222
www.sensaphone.com

Table of Contents

IMPORTANT SAFETY INSTRUCTIONS	III
CAUTION.....	iv
WARRANTY	v
CHAPTER 1: INTRODUCTION	13
PROGRAMMING EXPRESS	13
CHAPTER 2: INSTALLATION	15
OPERATING ENVIRONMENT	15
MOUNTING EXPRESS	15
STRAIN RELIEF	16
POWERING EXPRESS	16
TURNING EXPRESS ON	17
PHONE LINE	18
LINE SEIZURE	19
TEMPERATURE SENSOR	19
THE MICROPHONE	20
THE ALARM INPUTS	20
POWER SUPPLIES	23
WIRING SUMMARY	24
NOTICE.....	26
CHAPTER 3: COMMUNICATION PROGRAMMING ..	29
VOICE MESSAGES	29
ID NUMBER.....	31
DIAL-OUT TELEPHONE NUMBERS.....	32
SPECIAL DIALING	33
TONE OR PULSE DIALING	34
CALL DELAY TIME	35
INTERCALL TIME	36
CALL PROGRESS.....	37
VOICE REPETITIONS	38
MAX CALLS.....	38
TELEPHONE ANSWERING DEVICE COMPATIBILITY...	39

- LISTEN-IN TIME40
- SECURITY CODE41
- LOCAL MUTE42
- CHAPTER 4: ALARM PROGRAMMING45**
 - ENABLE/DISABLE INPUTS45
 - CONFIGURE INPUT NORMALITY.....46
 - INPUT RECOGNITION TIME47
 - TEMPERATURE SCALE48
 - TEMPERATURE LIMITS.....48
 - ENABLE/DISABLE TEMPERATURE INPUT50
 - TEMPERATURE RECOGNITION TIME50
 - TEMPERATURE CALIBRATION.....52
 - AC POWER MONITORING ENABLE/DISABLE.....53
 - POWER RECOGNITION TIME.....54
 - EXIT DELAY.....55
- CHAPTER 5: CALL-IN COMMANDS57**
 - ALARM ACKNOWLEDGMENT.....57
 - STATUS REPORT58
 - PHONE COMMANDS.....61
- CHAPTER 6: USER OPTIONS65**
 - tone/pulse ACKNOWLEDGMENT66
 - REMOTE SECURITY.....66
 - REDIAL ON BUSY.....67
 - THERMISTOR ALTERNATIVE.....67
 - OUTPUT CONTROL.....68
 - DIALING PATTERN.....69
- CHAPTER 7: THE OUTPUT73**
 - AUTOMATIC CONTROL73
 - MANUAL CONTROL.....73
 - POWER LIMITATIONS.....74
 - EXAMPLE WIRING.....74
 - POSSIBLE APPLICATIONS75
- CHAPTER 8: PROGRAMMING SUMMARY77**

MONITORING FUNCTIONS.....	77
COMMUNICATIONS FUNCTIONS.....	79
USER OPTIONS.....	81
CHAPTER 9: EXPRESS EXAMPLES83
SAMPLE STRATEGY	84
COMMUNICATIONS PARAMETERS.....	84
MONITORING PARAMETERS	85
EXPRESS EXAMPLES.....	85
CHAPTER 10: TROUBLESHOOTING93
APPENDIX A: PROPER OPERATION CHECK97
APPENDIX B: ACCESSORIES99
APPENDIX C: THERMISTOR LOOK-UP TABLE101
APPENDIX D: RETURNING UNIT FOR REPAIR103

CHAPTER 1: INTRODUCTION

Welcome to the Sensaphone Express.

Express is an advanced environmental monitoring system that combines digital speech recording technology with your creativity. With Express, you can enjoy comprehensive monitoring capability and the versatility of recording your own voice for the dial-out alarm and ID messages.

Express features monitoring of up to 4 dry contacts, a built-in temperature sensor, and on-board power monitoring. In addition, Express has a built-in microphone to allow remote monitoring of on-site sounds.

Express can call up to 8 phone numbers using pulse or Touch Tone dialing. It is able to share a phone line with answering devices such as answering machines and modems. Express's call progress feature detects a busy signal or no answer. The Dialing Pattern option allows you to customize your dial-out sequence.

Express is equipped with a rechargeable Gel Cell battery backup to ensure continued monitoring through power failure. In addition, Express has non-volatile memory to retain programming and voice messages with no power at all.

PROGRAMMING EXPRESS

Reading this instruction manual will help you install and program Express easily. Programming and voice recording are performed locally using the built-in keypad. Some programming and voice messages can also be accessed via touch-tone phone.

If there are any questions or problems that arise upon installation or operation, please contact Technical Support at:

PHONETICS, INC.
901 Tryens Road
Aston, PA 19014
Phone: 610-558-2700
FAX: 610-558-0222
support@sensaphone.com

ABOUT THIS MANUAL

This manual is comprised of the instructions and commands necessary to install and program Express. In addition, summary and application chapters are included to help you speed programming and to understand Express's features.

CHAPTER 2: INSTALLATION

This chapter provides information to install the Sensaphone® Express. Please read the entire chapter before starting.

Within the packaging will be a Warranty Registration Card. Please take the time to fill this out and mail. The Limited 1 Year Warranty is explained in the back of this manual.

CAUTION: Express is a sensitive electronic device. Personnel and work area should be grounded before handling this device. Do not install Express near strong electrostatic, electromagnetic, magnetic or radioactive fields.

OPERATING ENVIRONMENT

Express should be mounted and operated in a safe environment. The temperature range that Express can operate in is 32°F to 120°F (0°C to 48°C). If Express needs to operate below freezing, a strip heater should be added.

MOUNTING EXPRESS

When you receive Express, carefully remove it from the shipping container. On the top and bottom of the enclosure are mounting holes to attach the unit to the wall. (*See Figure 1*)

Use #12 screws and appropriate anchoring hardware to mount the unit securely. Mount it in an upright position so that you can easily gain access to the front panel. An easily accessible power outlet and telephone jack must be located nearby. Decide where you will be mounting Express and drill holes accordingly.

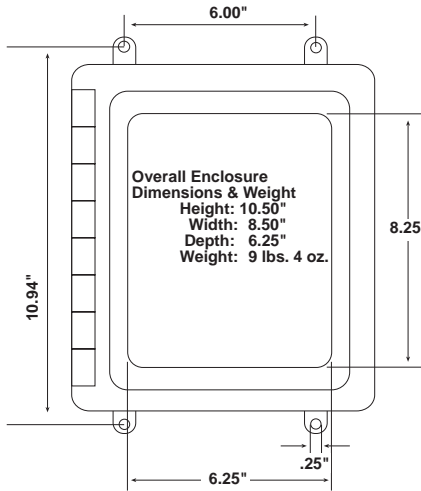

Figure 1: Mounting Express

STRAIN RELIEF

Strain relief clamps are provided in the Express enclosure to prevent wiring from being pulled from the circuit board or damaged when passing through the enclosure. To use the strain relief, thread wires through the clamp and clear rubber bushing. Position the bushing in the clamp and tighten the screws on either side so that the wiring does not move.

POWERING EXPRESS

Express is provided with a 12V AC power transformer. This should be plugged into a 115V AC outlet, $\pm 10\%$, 60Hz.

Wire from the transformer is pre-wired to the terminals labelled AC.

GROUNDING

Express should be earth grounded by connecting a true earth ground to the terminal labelled EG. This is not essential for Express to operate, but it is necessary to prevent possible damage caused by a lightning strike in or around the immediate area.

BACKUP BATTERY

Express has a 12V 1.9AH sealed Gel Cell (lead acid) rechargeable battery. This will provide approximately 12 hours backup time. The battery comes pre-wired with the red wire attached to the BAT terminal and the black wire attached to the G terminal.

Express will automatically charge the battery whenever the power switch is turned on and the power transformer is plugged in. The unit also includes special circuitry to prevent the battery from being damaged in the event of an extended power outage. When the battery runs down to 9V, the unit will automatically disconnect it. The battery will remain disconnected until it charges back up to 12.3 volts. The battery should provide 5 years of backup service before needing replacement.

Also included is a 3V lithium battery to retain user recorded voice messages when the unit is turned off. This battery will provide two years of backup time while the unit is off and up to 10 years of intermittent use.

CAUTION

Danger of explosion if battery is incorrectly replaced. Replace only with the same or equivalent type recommended by the manufacturer. Dispose of used batteries according to the manufacturer's instructions.

ATTENTION

Il y a danger d'explosion s'il y a remplacement incorrect de la batterie. Remplacer uniquement avec une batterie du même type ou d'un type équivalent recommandé par le constructeur. Mettre au rebut les batteries usagées conformément aux instructions du fabricant.

TURNING EXPRESS ON

Now that Express has power, the ON-OFF switch may be turned on. Express's BATTERY OK LED will go on and glow steadily. The unit will say: "OK."

When the unit is turned off, it is disabled but your voice messages and programming are retained by the 3V lithium battery. In the off position, the 3V lithium battery is in use. The 12V battery backup is not.

LED INDICATORS

Express has nine LED indicators on the front panel. These are provided to indicate the alarm status, the battery condition and calling status of the unit.

ALARM LEDs

The alarm LEDs show three different input conditions as described below:

LED OFF: Input condition OK, no alarms exist.

LED BLINKING: Input is in alarm and has NOT been acknowledged.

LED STEADY: Input is in alarm and has been acknowledged.

BATTERY OK LED

The battery OK LED indicates the following battery condition:

LED STEADY: Battery is charged and ready to power the unit if main power fails.

LED BLINKING: Battery voltage is low and will provide only limited backup power.

LED OFF: The battery voltage is very low and may need to be replaced if it fails to recharge.

PHONE LED

The phone LED indicates whether or not the unit is presently communicating on the phone line.

PHONE LINE

The Sensaphone Express comes prewired with the telephone cord connected to the unit's PHONE LINE jack. Connect this cord to any standard telephone system that will accept pulse or

tone dialing. Express dials using loop start only and will recognize ringer frequencies from 16 to 60Hz.

NOTE: Express will operate with all standard 2-wire analog telephone systems that accept pulse or tone dialing.

Certain private telephone systems and public switching equipment may not accept Express dialing or may generate an unacceptable ring signal. In those cases, a dedicated line may be required for Express. Consult the supplier of your telephone system if you encounter problems.

CAUTION: Never install telephone wiring during a lightning storm. Never install telephone jacks in wet locations unless the jack is specifically designed for wet locations. Never touch uninsulated telephone wires or terminals unless the telephone line has been disconnected at the network interface. Use caution when installing or modifying telephone lines.

LINE SEIZURE

Line seizure gives the Express unit the ability to "seize" the telephone line when it needs to dial out. For example, if an emergency occurs which puts the Express into alarm mode, the unit will be able to dial out even if a telephone had been left off the hook. Next to the PHONE LINE jack there is another jack labeled LINE SEIZE. This jack can be used to share the line with other devices (telephone, fax machine, modem) and to give priority to the Express unit in the event of an emergency. To make use of this feature you must have all extension devices originate from the LINE SEIZE jack. Whenever the unit must make an alarm phone call the unit will disconnect any current phone calls and seize the line for its own use. The unit will continue to seize the line until the alarm has been acknowledged.

TEMPERATURE SENSOR

Express is provided with a 2.8K remote temperature sensor. This is pre-wired to the temperature terminals labelled TMP and G. It is on a 20 ft. cable. It is used to measure temperature for your

application. The temperature range of the sensor is -60° to 175°F (-58° to 80°C).

THE MICROPHONE

Express is provided with a polarity-sensitive microphone. It is pre-wired on a 25 ft. cord. The microphone is used for recording alarm messages and remote monitoring of on-site sounds.

THE ALARM INPUTS

Express can monitor up to four dry contacts. These sensors are to be wired to the terminal block located directly to the right of the line seize jack. An alarm input can be used with any normally open (N.O) or normally closed (N.C.) input device. Open is when there is no contact and closed is when a contact exists. Express will adapt to N.O. or N.C. sensors when the unit's ID number is programmed (*see Chapter 4*).

Each alarm input consists of two screws called a terminal pair. Each screw in the terminal pair is labelled. The labels are:

1 C, 2 C, 3 C, and 4 C. You must determine what type of sensor will be connected to each alarm input. *See Figure 2*.

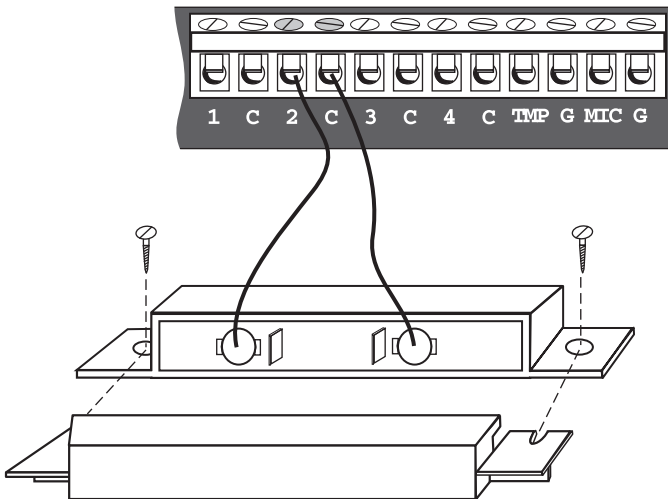

Figure 2: Connecting a sensor to an input terminal

After you have selected the sensor, loosen the two screws of the alarm input to which it will be connected. Two wire leads are used to connect any monitoring sensor. Fasten one lead to the numbered screw (1, 2, 3, or 4) and the other lead to the common screw (C). Tighten both screws. Express may recite an alarm message as you connect the sensor. If it does, press the ALARM CANCEL key to stop it.

Do not use sensors, switches, or relays that supply any voltage or current to Express.

NOTE: Any N.O. or N.C. sensor can be attached to Express using 22-gauge wire. The sensor can be up to 1500 ft. from the unit. The total resistance of the circuit cannot be greater than 50 ohms. Use wire appropriate for the application. See Length of Wire, later in this chapter.

Express may have more than one sensor connected to the same terminal. However, the normal condition for each sensor on the same terminal must be identical (either all N.O. or all N.C.).

NORMALLY CLOSED SENSORS

To wire more than one normally closed sensor on one input, they must be connected in series. Connect one lead from the first sensor to the numbered screw of the terminal pair. Next, take the other lead from the first sensor and connect it to one lead from the next sensor. Continue connecting sensors end-to-end until you have connected all of your sensors. Take the second lead from your last sensor and connect it to the common screw of the terminal pair. *See Figure 3.*

Multiple N.C. inputs are typically magnetic reed switches to monitor the security of windows and doors.

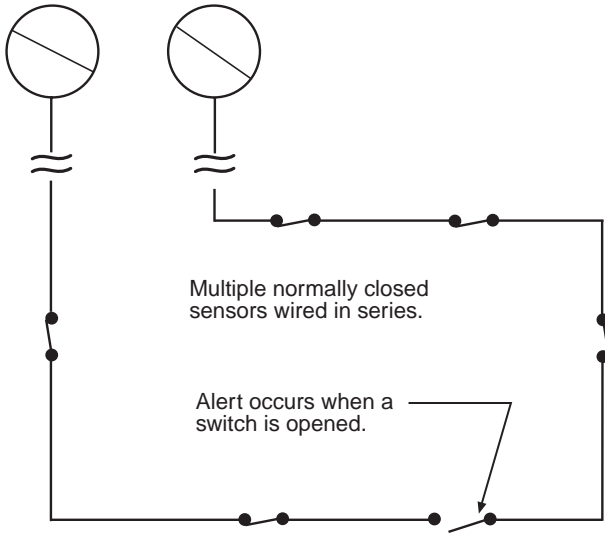

Figure 3: Connecting multiple N.C. sensors to one input terminal

NORMALLY OPEN SENSORS

To wire several normally open sensors to one alert input, connect them in parallel. To do this, take one lead from each sensor and attach it to the numbered terminal. Then, take the second lead from each sensor and attach each to the corresponding common screw.

See Figure 4.

Multiple N.O. inputs are typically TEMP^oALERTs to monitor the temperature in several different locations simultaneously.

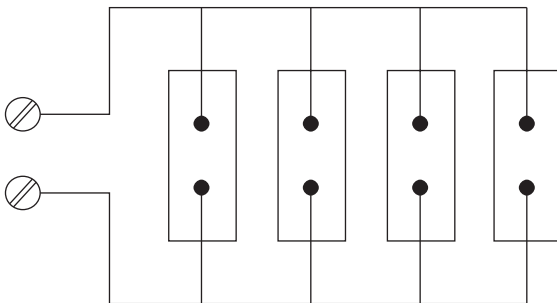

Figure 4: Attaching multiple N.O. sensors to one input terminal

SHIELDED WIRE

Express is designed to work in most installations without the need for shielded wire. This does not apply to wire run in conduit with other noise-generating conductors, such as 60Hz AC. It is strongly recommended that input wiring be run in a conduit separated from AC power or output wiring. When wire runs are long or are in close proximity to large power consuming, power generating, or power switching equipment, it is recommended that SHIELDED WIRE be used.

LENGTH OF WIRE

Temperature Sensors - It is recommended that long wire runs be avoided when using a thermistor as a sensor. A long run of wire could alter the RESISTANCE of the circuit therefore providing an inaccurate temperature reading on the input. Below is a chart of recommended gauges and wire lengths:

<u>Minimum Wire Gauge</u>	<u>Maximum Wire Length</u>
#26	250 feet
#24	700 feet
#22	1500 feet
#20	2500 feet

Dry Contact Sensors - The total resistance of the loop cannot exceed 50 Ohms. Use the appropriate gauge wire for your application.

NOTE: All wiring should comply with Section 17 of the UL requirements.

POWER SUPPLIES

Express has two power supplies available from the PC board. They are provided to power your external sensors or output devices.

Power Supplies: 5 Volt supply; 12 Volt supply

Maximum Current Available: 100 mA total (for both supplies combined, not 100 mA for each supply.)

WIRING SUMMARY

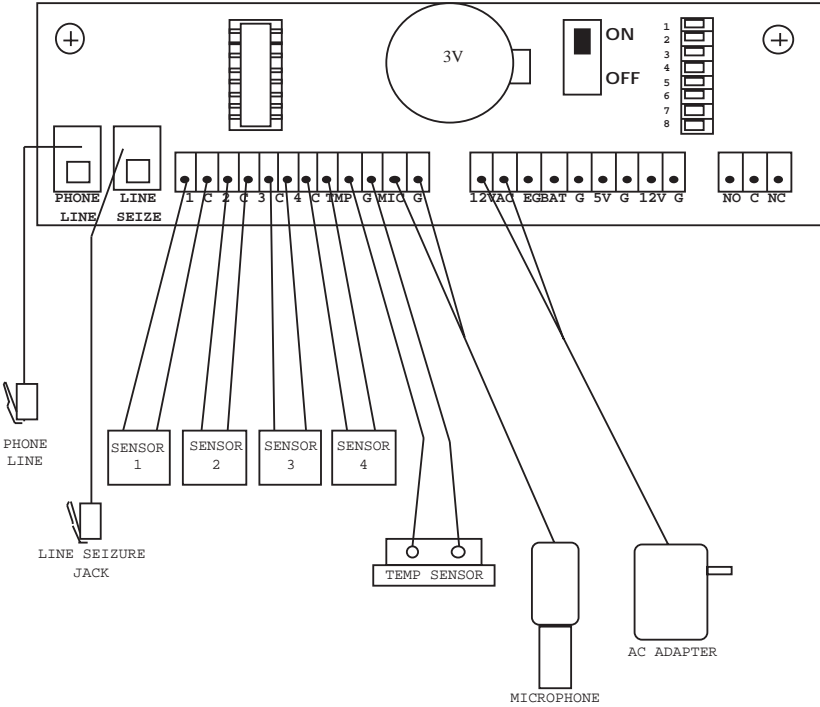

Mounting Dimensions: 10.75" x 6.00"; holes: .25" diameter.

Enclosure Dimensions: 11.7" x 8.4" x 5.9"

Power: AC adapter with 6 ft. cord provided. Plugs into standard 120VAC wall outlet

Phone Line: Standard RJ11C phone jack on 10 ft. cord provided.

Line Seize: RJ11C modular connector to connect telephone extensions.

Temperature monitoring: 2.8K remote temperature sensor on 25 ft. cable, provided.

Microphone: Microphone on 25 ft. cord provided.

Dry contact inputs 1 to 4: 2 conductor 22 gauge wire recommended for each. Not included.

FCC REQUIREMENTS

PART 68 - This equipment complies with Part 68 of the FCC rules. On the outside of the enclosure there is a label that contains, among other information, the FCC Registration Number and the Ringer Equivalence Number (REN) for this equipment. You must, upon request, provide this information to your local telephone company.

The REN is useful to determine the quantity of devices that you may connect to your telephone line and still have all of those devices ring when your telephone number is called. In most, but not all areas, the sum of the REN's of all devices connected to one line should not exceed five (5.0). To be certain of the number of devices that you may connect to your line, you may want to contact your local telephone company to determine the maximum REN for your calling area.

This equipment may not be used on coin service provided by the telephone company. Connection to party lines is subject to state tariffs.

Should EXPRESS cause harm to the telephone network, the telephone company may discontinue your service temporarily. If possible, they will notify you in advance. But if advanced notice isn't practical, you will be notified as soon as possible. You will be informed of your right to file a complaint with the FCC. The telephone company may make changes in its facilities, equipment, operations, or procedures that could affect the proper functioning of your equipment. If they do, you will be notified in advance to give you an opportunity to maintain uninterrupted telephone service.

If you experience trouble with this equipment, please contact:

PHONETICS, INC.
901 Tryens Road
Aston, PA 19014
610.558.2700
Fax: 610.558.0222

for information on obtaining service or repairs. The telephone company may ask that you disconnect this equipment from the network until the problem has been corrected or until you are sure that the equipment is not malfunctioning.

PART 15 - This equipment has been tested and found to comply with the limits for a Class A digital device, pursuant to Part 15 of the FCC Rules. These limits are designed to provide reasonable protection against harmful interference when the equipment is operated in a commercial environment. This equipment generates, uses and can radiate radio frequency energy and if not installed and used in accordance with the instruction manual, may cause harmful interference to radio communications. Operation of this equipment in a residential area is likely to cause harmful interference in which case the user will be required to correct the interference at his own expense.

NOTICE

The Canadian Department of Communications label identifies certified equipment. This certification means that the equipment meets certain telecommunications network protective operational and safety requirements. The Department does not guarantee the equipment will operate to the user's satisfaction.

Before installing this equipment, users should ensure that it is permissible to be connected to the facilities of

the local telecommunications company. The equipment must also be installed using an acceptable method of connection. In some cases, the company's inside wiring associated with a single line individual service may be extended by means of a certified connector assembly (telephone extension cord). The customer should be aware that compliance with the above conditions may not prevent degradation of service in some situations.

Repairs to certified equipment should be made by an authorized Canadian maintenance facility designated by the supplier. Any repairs or alterations made by the user to this equipment, or equipment malfunctions, may give the telecommunications company cause to request the user to disconnect the equipment.

Users should ensure for their own protection that the electrical ground connections of the power utility, telephone lines and internal metallic water pipe system, if present, are connected together. This precaution may be particularly important in rural areas.

CAUTION: Users should not attempt to make such connections themselves, but should contact the appropriate electric inspection authority, or electrician, as appropriate.

The Load Number (LN) assigned to each terminal device denotes the percentage of the total load to be connected to a telephone loop which is used by the device to prevent overloading. The termination on a loop may consist of any combination of devices subject only to the requirement that the total of the Load Numbers of all the devices does not exceed 100. For Sensaphone EXPRESS, the Load Number is 9.

CHAPTER 3: COMMUNICATION PROGRAMMING

This chapter explains the keyboard functions for the communications operations for Express. This includes programming, interrogating and/or resetting of:

- Voice messages
- ID Number
- Dial-out phone numbers
- Special dialing
- Tone or pulse dialing
- Rings until answer
- Call delay time
- Intercall time
- Call Progress
- Voice repetitions
- Maximum number of calls
- Telephone Answering Device compatibility
- Listen-in time
- Security code
- Local voice mute

VOICE MESSAGES

Express's digital speech recording feature allows you to record your own voice for the four dial-out alarm messages and the ID message. This means that when Express calls you during an alarm, you will receive your personalized voice message telling you exactly what alarm condition exists. You can record a separate message for each of the four inputs. The message can be a maximum of 8 seconds. The ID message can be a maximum of 10.5 seconds. Each input has a default dialout message if none is programmed.

To program the voice message for input 1:

1. Press the SET key
2. Press the MESSAGE key
3. Press number key 1
4. Holding the microphone approximately 6 inches from your mouth, say your prepared message clearly.
5. Press the ENTER key when finished speaking. NOTE: Express will not beep when you press ENTER as it does for other commands. Express will beep when the 8 seconds is over.



To program the voice messages for inputs 2-4, press number keys 2-4 accordingly for step 3.

To program the ID voice message:

1. Press the SET key
2. Press the MESSAGE key
3. Press the ID# key
4. Holding the microphone approximately 6 inches from your mouth, say your 10.5-second prepared message clearly.
5. Press the ENTER key when finished speaking. Express will not beep when ENTER is pressed. It will beep when the 10.5 seconds is over.



To play back your messages:

1. Press the WHAT IS key
2. Press the MESSAGE key

- Press number key 1, 2, 3, or 4 to hear the corresponding recorded input message. Press the ID# key to hear the ID message. Express will play back your recorded message. If a message had been erased, a beep will be heard instead.



To delete a message:

- Press the SENSOR ON/OFF key
- Press the MESSAGE key
- Press number key 1, 2, 3, or 4 to erase an input message. Press the ID# key to erase the ID message.

Express will say "OK."



ID NUMBER

The ID number is the identification number of the Express. This number may be the same as the telephone number where the unit is installed, or it may be designated using any number that best suits your application. The purpose of the ID number is to immediately provide the source of any alarm, especially when using multiple Express units in a complex monitoring system. When the Express is called from a remote location, it always begins its message with the identification number:

"Hello, this is (ID Number)."

The ID number also provides the method for configuring the input normality. See Chapter 4 "Configure Input Normality" for information on programming the ID number.

DIAL-OUT TELEPHONE NUMBERS

The Sensaphone Express can store up to eight 32-digit phone numbers. These are the numbers that will be called during an alarm dial-out. The numbers are dialed sequentially 1 through 8. Therefore, program the first number you want called as Phone #1, the second one as Phone #2, and so on. A pause, pound or asterisk can be added to the phone number to access different phone and beeper systems. See *Special Dialing*.

To program the dial-out telephone numbers:

1. Press the SET key
2. Press the PHONE NUMBER key
3. Select the Phone number (keys 1-8)

Express will say "Enter number."

4. Enter the phone number using the number keys
5. Press the ENTER key

Express will say "OK."



To interrogate a dial-out telephone number:

1. Press the WHAT IS key
2. Press the PHONE NUMBER key
3. Select the Phone number (keys 1-8)

Express will recite the number programmed. If there is no number programmed, Express will say "No number."



To delete a Phone number:

1. Press the SET key
2. Press the PHONE NUMBER key

3. Select the Phone number (1-8) to erase

Express will say *“Enter number.”*

4. Press the ENTER key

Express will say *“OK.”*



SPECIAL DIALING

Express has provisions for special dialing sequences. There are four keys that represent special functions when used within a phone number. The SET key produces a # tone. The WHAT IS key produces the * tone. The PAUSE key represents a two second pause in dialing. The CODE key instructs Express to wait until the call is answered before continuing. These provisions are mainly for dialing out to a beeper or pager, or when the phone system requires dialing an access number to reach an outside line.



The following is a typical scenario for dialing a pager:

SET PHONE 1

1 800 555 1212 CODE PAUSE 1 2 3 4 #

ENTER

Express will dial the pager number, wait for it to answer, pause and then give 1234#.

NOTE: When interrogating a Phone Number, a PAUSE is represented as a beep, the asterisk (*) = 11, the pound (#) = 12, and CODE = 14.

STONE OR PULSE DIALING

Express can dial out in pulse or touch-tones. All numbers will be called using the chosen dialing method. The default is TONE.

To program as either tone or pulse:

1. Press the SENSOR ON/OFF key
2. Press the TONE key

Express will respond by saying "OFF" to indicate that tone dialing is off, or "ON" to indicate that tone dialing is on.

3. Repeat key sequence to change



RINGS UNTIL ANSWER

The rings until answer is the number of rings that must occur before Express answers the phone. This value can be from 1 to 32. The default value is 1.

To program rings until answer:

1. Press the SET key
2. Press the RINGS key

Express will say "Enter number."

3. Using the number keys, enter a value
4. Press the ENTER key

Express will say "OK."



(enter number)



To interrogate:

1. Press the WHAT IS key

2. Press the RINGS key
Express will recite the current value.



CALL DELAY TIME

The call delay time is the length of time Express will wait after an alarm is recognized before it starts the dial-out sequence. This is only for the first call. To set delay time between calls, see INTERCALL TIME. The default time is 30 seconds. The call delay time can be programmed from 0 to 272 minutes 59 seconds.

The purpose of Call Delay is to allow time for personnel at the Express unit's installation site to respond to and cancel an alarm before dial out begins. During this time, the unit will audibly repeat its "alarm" message.

To program call delay time:

1. Press the SET key
2. Press the CALL DELAY key
Express will say "Enter seconds."

3. Enter the seconds using the number keys
4. Press the ENTER key
Express will say "OK."



To interrogate:

1. Press the WHAT IS key
2. Press the CALL DELAY key

Express will recite the programmed time.



INTERCALL TIME

The Intercall Time is the programmable period of time the Express unit waits to call subsequent telephone numbers. Intercall Time is activated **only after alarm dial-out to the first telephone number fails to be acknowledged**. This period can be programmed from 0 to 272:59 minutes. The default Intercall Time is 30 seconds.

If an incoming telephone call is made to the unit during Intercall Time (in between dialing of subsequent telephone numbers to report an alarm), it will answer the incoming call and immediately report any existing alarms. The manner in which the incoming call is answered depends upon whether or not TAD is enabled or disabled:

If TAD (Telephone Answering Device) is enabled, Rings Until Answer will be 1.

If TAD is disabled, Rings Until Answer will be 10.

To program intercall time:

1. Press the SET key
2. Press the INTERCALL TIME key

Express will say, *"Enter minutes."*

3. Using the number keys, enter the number of minutes
4. Press the ENTER key

Express will say *"Enter seconds."*

5. Using the number keys, enter the number of seconds
6. Press the ENTER key

Express will say *"OK."*



To interrogate:

1. Press the WHAT IS key
 2. Press the INTERCALL TIME key
- Express will recite the programmed time.



CALL PROGRESS

Express monitors call progress when it dials out for an alarm. If Express encounters a busy signal or receives no answer after 8 rings, the unit hangs up, waits the programmed intercall time and then dials the next phone number.

When dialing some beeper/pager services, the line may be answered before receiving a ringback. This may interfere with the call progress detection and result in a failed call to the beeper/pager. If this occurs, disable call progress detection.

To disable call progress detection:

1. Press the Sensor On/Off key
 2. Press the Phone Number key
- Express will say “Off” to indicate that call progress has been turned off.
3. Repeat key sequence to change



VOICE REPETITIONS

The voice repetitions is how many times Express will repeat the alarm message per phone call when it dials out. This can be programmed from 0 to 255 repetitions. The default value is 3 repetitions.

To program the voice repetitions:

1. Press the SET key
2. Press the VOICE REPS key

Express will say, "Enter number."

3. Using the number keys, enter a value
4. Press the ENTER key

Express will say "OK."



To interrogate:

1. Press the WHAT IS key
2. Press the VOICE REPS key

Express will repeat the number programmed.



MAX CALLS

This value determines the maximum number of calls Express will make if none of the calls are acknowledged. If the number of calls reaches this value, Express will automatically acknowledge the alarms and stop the dialout. The unit indicates it has reached max calls by saying "warning message received by telephone number (ID number)." The max calls can be programmed from 0 to 255. The default is 100.

NOTE: If only one Phone Number is programmed, Express will dial a maximum of 15 times, regardless of the programmed value of max calls.

To program max calls:

1. Press the SET key
2. Press the MAX CALLS key

Express will say *“Enter number.”*

3. Using the number keys, enter a value
4. Press the ENTER key

Express will say *“OK.”*



To interrogate:

1. Press the WHAT IS key
2. Press the MAX CALLS key

Express will recite the value of max calls.



TELEPHONE ANSWERING DEVICE COMPATIBILITY

Express can be used on the same telephone line as a telephone answering device, such as an answering machine, fax machine, or modem. This feature allows you to call in to Express and bypass the answering device.

To use TAD:

1. Program Express' RINGS UNTIL ANSWER to a greater number than the rings until answer for your answering device. For example, Express RINGS = 5, device rings = 3.
2. Press the SENSOR ON/OFF key

3. Press the TAD key. Express will say "On." (If Express says "Off" repeat steps 2 & 3.)
4. Once TAD is on, allow the phone to ring once when you call the unit and then hang up. Express recognizes that a call was made and activates a 30 second internal timer. This allows you 30 seconds to call back the Express unit.
5. Call back within 30 seconds. Express will override the answering device on this incoming call and answer the phone on the first ring. Express resets the TAD timer after **one** incoming call is received. If you want to call the unit again, you must repeat steps 4 and 5.



LISTEN-IN TIME

The listen-in time is the amount of time you can listen to sounds at the microphone site during a status call-in. The programmable range is 0 to 255 seconds. The default setting is 15 seconds.

To program the listen-in time:

1. Press the SET key
2. Press the LISTEN TIME key

Express will say "Enter seconds."

3. Using the number keys, enter the seconds
4. Press the ENTER key

Express will say "OK."



To interrogate:

1. Press the WHAT IS key
2. Press the LISTEN TIME key

Express will recite the time programmed.



SECURITY CODE

The security code is a 4-digit number that you program to prevent unauthorized access to Express' programming. Locally, when the security code is employed, it will lock the keyboard, not allowing the programmed parameters to be changed. You may only interrogate the unit using the WHAT IS key. You must unlock the keyboard by entering the security code to change the programming parameters.

For call-in access, the position of the REMOTE SECURITY PIN (*see Chapter 6*) determines whether the security code must be entered via touch-tone phone to obtain programming access. You may set the remote security pin so that Express will ignore the code to allow access during a dial-in. Or, you may set the remote security pin to check the code when you call in. If you enter the correct code, you will gain access to Express to use the phone commands. If you enter the incorrect code, Express will hang up. You cannot program or change the security code remotely. For an explanation of how to use the security code during a call in, see Chapter 5.

To program the security code / lock the keyboard:

1. Press the SET key
2. Press the CODE key

Express will say "Enter code."

3. Using the number keys, enter 4 digits
 4. Press the ENTER key
- Express will say "OK."



To unlock the keyboard:

1. Press the WHAT IS key
2. Press the CODE key

Express will say "Enter code."

3. Using the number keys, enter your 4 digit code. (If you enter the incorrect code, Express will say "Error.")
4. Press the ENTER key

Express will say "OK" if the correct code was entered.

NOTE: You may not interrogate the security code. The WHAT IS key is used to unlock the keyboard when the correct code is entered.



LOCAL MUTE

When Express dials out with an alarm, it recites the alarm message over the phone and at the monitor site. The local voice mute command allows you to mute the voice repetitions at the monitor site.

To locally mute Express:

1. Press the SENSOR ON/OFF key
2. Press the MUTE key

Express will say "On" to indicate that the mute is on. It will say "Off" to indicate when the mute is off.

3. Repeat key sequence to change.



CHAPTER 4: ALARM PROGRAMMING

This chapter explains the keyboard commands for the monitoring functions of Express. This includes:

- Enable/disable inputs
- Configure input normality—The ID number
- Input recognition time
- Temperature scale
- Temperature limits
- Enable/disable temperature inputs
- Temperature recognition times
- Temperature calibration
- AC power monitoring enable/disable
- AC Power recognition time

ENABLE/DISABLE INPUTS

This function allows you to enable or disable an input (1-4) to dial out during an alarm. An enabled input will respond to an alarm and allow dial-out. A disabled input will not initiate a dial-out. This command is useful while you are wiring your inputs or at any other time you would like the alarms to be ignored. The default setting for all inputs is enabled (on).

To enable/disable inputs:

1. Press the SENSOR ON/OFF key
2. Press the corresponding number key (1-4) of the input you want to enable/disable

Express will say “*Off*” to indicate disabled or “*On*” to indicate enabled.

3. Repeat key sequence to change



CONFIGURE INPUT NORMALITY

Inputs must be configured as normally open or normally closed. The default for all inputs is open. See Chapter 2 for an explanation on wiring inputs. Configuring the input normality is done by setting the unit's ID number. When the ID number is set, Express looks at the four inputs and establishes the present open/closed state as normal. Any change from that normal state is an alarm. The ID number is also usually programmed as the unit phone number. This number is recited during a status report and alarm dial-out report.

To set the status of the inputs as normal:

1. Disable the input (see above)
2. Wire the input
3. Press the SET key
4. Press the ID# key

Express will say, *"Enter number."*

5. Using the number keys, enter the unit's phone number
6. Press the ENTER key

Express will say *"OK"* if the number was accepted.

7. Enable the input

The inputs are now considered normal. If a normally closed input becomes open, an alarm will occur. If a normally open input becomes closed, an alarm will occur.



To interrogate the ID number and system status:

1. Press the WHAT IS key
2. Press the ID# key

Express will say *"Hello, this is ..."* followed by a recitation of the programmed ID# and a status report.

WHAT IS

*

9

ID#
STATUS
MUTE

INPUT RECOGNITION TIME

The input recognition time is the length of time an input must have an alarm continuously before Express will recognize the condition. If an alarm exists and then clears within the recognition time, it is never considered an alarm. This is useful to prevent nuisance dialouts for momentary alarm conditions or on self-correcting equipment. Each input can be programmed with a different recognition time. The default recognition time is 3 seconds. You may program the recognition time from 0 seconds to 272 minutes.

To program the recognition time:

1. Press the SET key
2. Press the REC TIME key
3. Press the corresponding input key (1-4)

Express will say *“Enter minutes.”*

4. Using the number keys, enter minutes
5. Press the ENTER key

Express will say *“Enter seconds.”*

6. Using the number keys, enter seconds
7. Press the ENTER key

Express will say *“OK.”*

SET
#7
REC TIME
POWER1
CALL DELAY

(enter minutes)

ENTER
OUTPUT

(enter seconds)

ENTER
OUTPUT

To interrogate the recognition time:

1. Press the WHAT IS key
2. Press the REC TIME key

3. Press the corresponding input key (1-4)

Express will recite the programmed recognition time for that input.



TEMPERATURE SCALE

Express can monitor temperature in degrees Fahrenheit or degrees Celsius. The default setting is Fahrenheit. NOTE: When switching from Fahrenheit to Celsius or vice versa, remember to reprogram your temperature limits accordingly.

To program the temperature scale:

1. Press the SENSOR ON/OFF key
2. Press the TEMP key

Express will either say "On" to indicate Celsius, or "Off" to indicate Fahrenheit.

3. Repeat key sequence to change

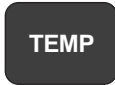
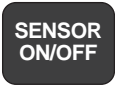

TEMPERATURE LIMITS

The following keyboard commands are used to set the low and high temperature limits. The default settings are Low Temp = 10° and High Temp = 100°. The range of programming is -60° to 300°F(-50° to 150°C). Note: the sensor included with Express has a sensory range of only -60° to 175°F (-50° to 80°).

To program the low temperature limit:

1. Press the SET key
2. Press the LOW TEMP key

Express will say *“Enter number.”*

- Using the number keys, enter the low temperature number.
If you want the number to be negative, press the PAUSE key followed by the number.

- Press the ENTER key

Express will say *“OK.”*



To program the high temperature limit:

- Press the SET key
- Press the HIGH TEMP key

Express will say *“Enter number.”*

- Using the number keys, enter the high temperature limit. If you want the number to be negative, press the PAUSE key followed by the number.

- Press the ENTER key

Express will say *“OK.”*



To interrogate the temperature limits:

- Press the WHAT IS key
- Press the LOW TEMP key to check the low temperature limit. Press the HIGH TEMP key to check the high temperature limit.



ENABLE/DISABLE TEMPERATURE INPUT

This feature allows you to enable or disable the temperature input to dialout for a temperature alarm. When the temperature input is enabled, it will cause a dialout for an alarm. If it is disabled, it will not cause a dialout. It is helpful to disable the temperature inputs while wiring thermistors and setting limits to prevent tripping an alarm.

To enable/disable the low temperature alarm:

1. Press the SENSOR ON/OFF key
2. Press the LOW TEMP key

Express will say “On” to indicate that the low temperature alarm is enabled, or “Off” to indicate the input is disabled.

3. Repeat key sequence to change



To enable/disable the high temperature alarm:

1. Press the SENSOR ON/OFF key
2. Press the HIGH TEMP key

Express will say “On” to indicate that the high temperature alarm is enabled, or “Off” to indicate the input is disabled.

3. Repeat key sequence to change



TEMPERATURE RECOGNITION TIME

The temperature recognition time is the length of time that a low or high temperature alarm must exist continuously before Express will recognize it as an actual alarm and start an alarm

dialout. If an alarm exists and then clears within the recognition time, it is never considered an alarm. The default setting is 3 seconds. You may set the recognition time from 0 seconds to 272 minutes.

To program the low temperature recognition time:

1. Press the SET key
2. Press the REC TIME key
3. Press the LOW TEMP key

Express will say *“Enter minutes.”*

4. Using the number keys, enter the number of minutes
5. Press the ENTER key

Express will say *“Enter seconds.”*

6. Using the number keys, enter the number of seconds
7. Press the ENTER key

Express will say *“OK.”*

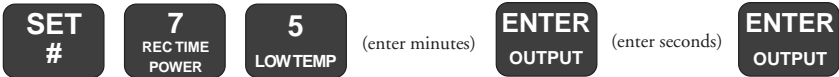

To program the high temperature recognition time:

1. Press the SET key
2. Press the REC TIME key
3. Press the HIGH TEMP key

Express will say *“Enter minutes.”*

4. Using the number keys, enter the number of minutes
5. Press the ENTER key

Express will say *“Enter seconds.”*

6. Using the number keys, enter the number seconds
7. Press the ENTER key

Express will say *“OK.”*

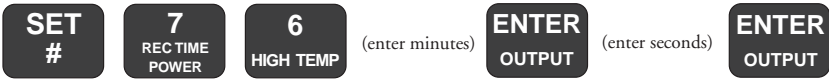

To interrogate the low or high temperature recognition time:

1. Press the WHAT IS key
2. Press the REC TIME key
3. Press LOW TEMP key for the low temperature recognition time. Press the HIGH TEMP key for the high temperature recognition time.

Express will recite the programmed low or high temperature recognition time.

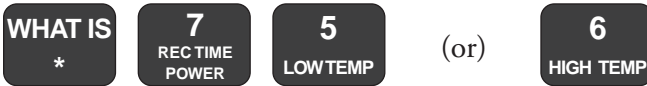

TEMPERATURE CALIBRATION

Due to tolerance variations or other factors, you may want to program an offset to calibrate the temperature input. The offset can be from 1 to 15, or -1 to -15. Setting a positive number will add that number to the temperature reading. Setting a negative number will subtract.

To calibrate the temperature input:

1. Press the SET key
2. Press the PAUSE key

Express will say *“Enter number.”*

- 2a. To program a negative number (i.e. -7), press the PAUSE key again.
3. Enter the number
4. Press the ENTER key

Express will say *“OK.”*



To interrogate the present calibration:

1. Press the WHAT IS key
2. Press the PAUSE key

Express will recite the programmed temperature calibration.



AC POWER MONITORING ENABLE/DISABLE

Express monitors AC power failure. This command enables or disables the power failure detection. When enabled, Express will monitor power and dial out if a valid failure occurs. When disabled, Express will not dial-out for a power alarm. The default setting is ON.

To enable/disable the power input:

1. Press the SENSOR ON/OFF key
2. Press the POWER key

Express will say “*On*” to indicate that the power input is enabled; OR, Express will say “*Off*” to indicate that the power input is disabled.

3. Repeat key sequence to change



POWER RECOGNITION TIME

The power recognition time is the length of time that a power failure must exist continuously before Express will recognize it as an actual alarm and start the dial-out sequence. The default setting is 5 minutes. You may program the power recognition time from zero seconds to 272 minutes.

To program the power recognition time:

1. Press the SET key
2. Press the REC TIME key
3. Press the POWER key

Express will say *"Enter minutes."*

4. Using the number keys, enter the number of minutes
5. Press the ENTER key

Express will say *"Enter seconds."*

6. Using the number keys, enter the number of seconds
7. Press the ENTER key

Express will say *"OK."*

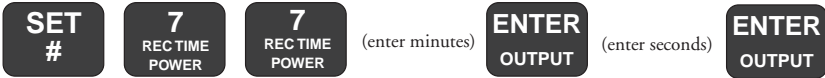

To interrogate the power recognition time:

1. Press the WHAT IS key
2. Press the REC TIME key
3. Press the POWER key

Express will recite the power recognition time.

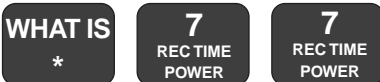

EXIT DELAY

The Exit Delay feature provides a temporary time period during which the unit will disregard an alarm condition. This is typically used in security applications where you may be monitoring a doorway, and in the process of exiting the building you must go through the monitored doorway. The Exit Delay will temporarily disable the input while you are leaving and then re-enable the input automatically. The Exit Delay is 20 seconds.

To start the Exit Delay:

1. Press the WHAT IS key
2. Press the STATUS key

Express will say *“Hello, this is ...”* followed by the ID# and a status report. Any alarms that occur during this recitation will be automatically cleared at the end of the status report. Any alarms that still exist will be automatically acknowledged and will not initiate dialout.



CHAPTER 5: CALL-IN COMMANDS

The following three functions are call-in commands. This means that to utilize them, you must call Express to execute the command. These features are: alarm acknowledgment, status report and the phone commands. Alarm acknowledgment can be accomplished and the status report can be obtained by pulse (rotary) or touch-tone phone. To use the phone commands, you must have a touch-tone phone.

ALARM ACKNOWLEDGMENT

When Express dials out with an alarm message, it will request *acknowledgment* before hanging up. Acknowledgment indicates to Express that the alarm message has been received. Upon acknowledgment, Express will cease the dial out sequence. The red LED for the alarm will stop blinking and glow steadily until the alarm condition has been resolved.

There are four ways that an alarm can be acknowledged: locally, by code, by call-in code acknowledgment and callback automatic acknowledgment.

1. Local alarm acknowledgment: On the Express keyboard is the ALARM CANCEL key. When an alarm exists, press the ALARM CANCEL key to acknowledge the alarm. Express will say “OK” and the red LED for that input will stop blinking.

2. Code acknowledgment: This method can only be used on a touch-tone phone. At the end of the alarm dial out message, Express requests acknowledgment that the message has been received by saying: “*Please acknowledge.*” You have 10 seconds to enter the code “555.”

To do this, press the number key 5 on the touch-tone phone keypad three times. Express will say: “OK. *Have a good day.*” The unit will then hang up.

If you did not enter a correct code within 10 seconds, Express will say: *"Have a good day."* Express will then hang-up. The alarm has not yet been acknowledged.

3. Call-in acknowledgment: This feature allows you to call-in to Express from a touch-tone phone and enter the acknowledgment code. To do this, call Express back after receiving an alarm dial out message. When Express answers, you will receive the alarm dial out message followed by a request for alarm acknowledgment: *"Please acknowledge."* You have 10 seconds to enter the code "555" by pressing the corresponding key on the touch-tone phone keypad.

If the correct code is entered within 10 seconds, Express will say *"OK. Have a good day,"* to indicate that the alarm was acknowledged. The dial out sequence is stopped. The red LED will stop blinking and glow steadily until the alarm condition is resolved.

If you did not enter a correct code within 10 seconds, Express will say: *"Have a good day,"* and then hang up.

4. Callback acknowledgment: This method is controlled by the configuration of pin #2 on the Express circuit board, *see Chapter 6*. When the shunt on pin #2 is in the on position, simply calling Express will acknowledge an existing alarm. You may call from either a touch-tone or pulse (rotary) phone to acknowledge the alarm.

To use, call Express. The unit will recite the dial out alarm message and then say: *"Alarm OK. Have a good day,"* to indicate that the alarm has been acknowledged.

STATUS REPORT

The status report feature allows you to call-in to Express and check the temperature and power status. If any alarm conditions exist, the alarm message will be recited. You can also listen in to on-site sounds and access the unit programming via phone commands.

NOTE: If you happen to call Express during the alarm dial out sequence (when an alarm condition exists but is not yet acknowledged) you will not receive a status report. Express will consider the call as either a call-in code acknowledgment or callback acknowledgment (*see above*).

To obtain a status report, call Express. The following is an example of what the unit will recite when it answers:

This is 555-3833 (unit phone number).
This is the equipment room located in Building One North (ID message).
The temperature is 70 degrees (current temperature).
The electricity is on (power status).
No alarm exists (alarm status).
Listen for 10 seconds (user-programmed listen-in time).
(on-site sound monitoring for 10 seconds)
OK.
(10-second wait for phone command access)
Have a good day. (hangs up)

If an alarm condition has been acknowledged but still exists, Express will recite that input's recorded alarm message. Below is an example of a status report with an acknowledged smoke alarm.

This is 555-3833.
This is the equipment room located in Building One North.
The temperature is 70 degrees.
The electricity is on.
Smoke has been detected. A fire emergency is possible (recorded alarm message).
Listen for 10 seconds.
(on-site sound monitoring)
OK.
(10-second wait for phone command access)
Have a good day.
(hangs up)

If the power is out but has not reached the recognition time to be considered an alarm, Express will recite the following message during the status report:

“... The temperature is 70 degrees.

The electricity is off.

No alarm exists.

Listen for ...”

If the power is out and has reached the recognition time to be considered an alarm, Express will recite:

“... The temperature is 70 degrees.

The electricity is off.

Listen for ...”

Access to programming: The unit allows you to access and change some of your programming remotely using a touch-tone telephone. To initiate access, call the unit and listen to the entire status report. Towards the end of the report the unit will say “OK.” Press any key on your touch tone telephone within 10 seconds and the unit will again say “OK” and enter remote programming mode. The commands for this mode are described in the following section, Phone Commands.

Remote programming access may be restricted by using the security code. This code is the same as the one for keypad security. You may, however, independently enable or disable remote security code requirements by moving one of the shunts described in Chapter 6.

If a security code has been programmed and the remote security option is enabled, the unit will first ask you to enter the security code before allowing remote access. Upon correct entry of the security code the unit will say “OK.”

You may now program the Express unit remotely.

NOTE: You cannot permanently unlock the security code remotely. You must do so on the local keypad only (*see Chapter 3*).

PHONE COMMANDS

You can record, interrogate and program Express remotely using a touch-tone phone. This is accomplished through the phone commands. You may perform the following functions via touch-tone phone:

- What is:
 - Alert message 1
 - Alert message 2
 - Alert message 3
 - Alert message 4
 - ID message

- Record:
 - Alert message 1
 - Alert message 2
 - Alert message 3
 - Alert message 4
 - ID message

- Turn ON/OFF OUTPUT

- Enable/Disable:
 - Alerts 1-4
 - Low Temp
 - High Temp
 - Power

To use the phone commands, call Express. You will receive a status report. After the listen-in time, Express will say "OK." Press ANY KEY within 10 seconds to access the phone command mode. If this is done, Express will say "OK." You now have 30 seconds to enter a key command before Express will hang up. If you do not press a key within 30 seconds Express will say "*Have a good day,*" and disconnect. More than one command can be entered. The 30 second time out restarts at the end of each command.

To listen to a recorded alarm message:

1. Press the * key on your phone
2. Press the corresponding number key: 1-4, or
Press number key 9 to listen to an ID message.
Express will recite the recorded message

To record a message remotely:

1. Press the # key
2. For an alarm message, press the corresponding number key:
1-4.

To record the ID message, press number key 9.

3. After the beep, say your message clearly. The alarm message can be up to 8 seconds long. The ID message can be up to 10.5 seconds long.

Express will beep at the end of the time allotment.

To turn ON/OFF the output:

1. The output (pin #6) must be in the ON position for manual control. See Chapter 6 for explanation of pin #6.
2. To turn the output **ON**, press **O** (number 6) then **N** (number 6)
Express will say "On."
3. To turn the output **OFF**, press **O** (number 6) then **F** (number 3)

Express will say "Off."

If pin #6 is in the off position for automatic control, Express will say "Error" if you try to turn the output on or off.

To enable or disable an input:

1. Press the number key 0.
2. Press number key 1-4 to enable/disable alert 1-4
Press number key 5 to enable/disable Low Temp
Press number key 6 to enable/disable High Temp
Press number key 7 to enable/disable Power

3. Repeat key sequence to change

Express will say “*On*” to indicate the input is enabled or “*Off*” to indicate the input is disabled.

CHAPTER 6: USER OPTIONS

The following are user options designed to increase the versatility for Express's programming features. These options are accessed by setting shunts on pins on the circuit board. The pins are located to the right of the ON/OFF switch. There are seven user options available that are activated by placing the shunt in the ON or OFF position on the pin. This allows you to further customize Express to dial out and monitor according to your application. These options include:

- Tone/Pulse Acknowledgment
- Remote Security
- Automatic Redial on Busy
- Thermistor Alternative
- Output Control
- Dialing Options

When the shunt is in the left position, it is considered off.

When the shunt is in the right position, it is considered on.

To move a shunt:

1. Using a pair of narrow-tipped or needlenose pliers, pull the shunt up off the pins.
2. Move the shunt to the on or off position
3. Carefully push the shunt back into place.

Shunt in OFF position:

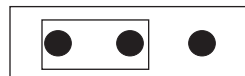

Shunt in ON position:

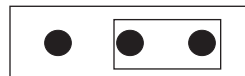

STONE/PULSE ACKNOWLEDGMENT

PIN#2: This feature enables you to acknowledge an alarm dial-out call from a pulse (rotary) phone. Use only when phones receiving the calls cannot use touch-tone. When the shunt is in the off position, alarm calls can only be acknowledged from a touch-tone phone by entering the code "555."

When the shunt on pin #2 is in the on position, alarm calls can be acknowledged by a pulse phone in addition to a touch-tone phone. Acknowledgment by pulse phone is accomplished by simply calling the unit back after receiving an alarm call. When Express answers the callback, the alarm(s) will be acknowledged. See diagram.

Touch-Tone acknowledgment only:

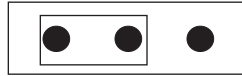

Pulse/Tone callback acknowledgment:

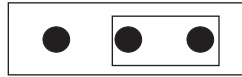

REMOTE SECURITY

PIN #3: This option is used to control remote access to Express' programming via telephone by enabling or disabling the security code (see Chapter 3). When the remote security code is enabled, the unit will prompt the user to enter the security code before programming access is granted. The remote security shunt can be used to enable or disable the security code during a call-in.

When the shunt on pin #3 is in the off position, the security code is disabled during a call-in. Interrogation and programming by the phone commands are accessible without knowing the security code.

When the shunt on pin #3 is in the on position and the security code is programmed, that code is needed to access programming with the phone commands.

Remote Security code Disabled:



Remote Security code Enabled:

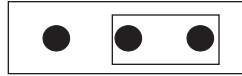

REDIAL ON BUSY

PIN #4: This feature determines what Express will do when it encounters a busy signal during an alarm dial-out. Depending on the position of this shunt, Express will either hang up and proceed to dial the next phone number, or it will dial the busy phone number again before going on to the next number.

This feature is set by moving shunt on pin #4 on the circuit board. When the shunt is in the off position, Express will hang-up if it encounters a busy signal and proceed with calling the next phone number.

When shunt on pin #4 is in the on position, Express will dial the phone number again if it encounters a busy signal. If the number is still busy, Express will hang up and proceed with the next phone number.

Hang up on busy:

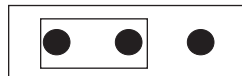

Dialback on busy:

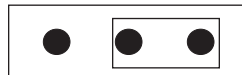

THERMISTOR ALTERNATIVE

PIN #5: Two different kinds of thermistors are compatible with Express for temperature monitoring — the 2.8K thermistor and the 10K thermistor. A 2.8K thermistor is included with Express.

However, you may use the 10K sensor as an alternate. You would use the 10K thermistor to get a broader range of temperature monitoring, particularly the warmer temperatures. Also, the 10K thermistor is available in a variety of special packages for specific locations for temperature sensing, indoor/outdoor, etc. See Appendix B for specifications.

To use the alternate 10K thermistor, you must switch the shunt on pin #5 on the circuit board. When the shunt is in the off position (to the left), the board is configured to use the normal (2.8K) sensor. This is the factory default. To use the 10K thermistor move the shunt to the on position. See diagram below.

Normal--2.8K Thermistor:



Alternate--10K Thermistor:

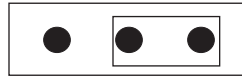

OUTPUT CONTROL

PIN #6: This pin allows you to control the output in one of two ways: automatically or manually. Automatic output control turns on the output when an alarm occurs on any of the inputs. The output is then turned off when the alarm is acknowledged. For manual control, you call into the unit and control the output via phone command. When the shunt is in the off position, it is configured for automatic control. Move the shunt to the on position for manual (phone command) control.

Automatic Output Control:

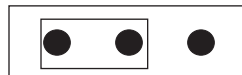

Manual Output Control:

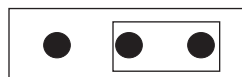

DIALING PATTERN

PINS #7 AND #8: Dialing pattern is a calling process that allows you to prioritize your phone list by assigning dial-out for certain alarms to Phone #1 only. There are four dialing choices available with this feature. Each allows you to program Phone #1 to be called only on specific alarms. Choice 1 enables dial-out to all Phone numbers for all alarms. Choice 2 enables dial-out to Phone #1 for input alarm #1. Choice 3 enables dial-out to Phone #1 for temperature alarms only. Choice 4 enables dial-out to Phone #1 for a power alarm only. Dialing choices are set by moving the shunts on pins #7 and #8. When a shunt is to the left, it is in the off position. When it is moved to the right, it is in the on position. For each dialing choice below, there are two diagrams. One is a chart illustrating the dial-out sequence for each option. The second diagram shows the shunt configurations for each option.

Key for Dialout Charts:

An 'x' indicates that a phone number is dialed for an input alarm.

1-4 = dry contact inputs

TL = temperature low

TH = temperature high

PW = power

DIALING CHOICE 1:

This choice enables dial-out for all alarms to all Phone numbers. All 8 Phone numbers will be called for alarms 1-4, Temp Low, Temp High, and power failure. To program dialing choice 1, move shunts for pins #7 and #8 to the off position.

Dialout Chart - Choice 1

		PHONE # 1 - 8							
		1	2	3	4	5	6	7	8
INPUTS	01	x	x	x	x	x	x	x	x
	02	x	x	x	x	x	x	x	x
	03	x	x	x	x	x	x	x	x
	04	x	x	x	x	x	x	x	x
	TL	x	x	x	x	x	x	x	x
	TH	x	x	x	x	x	x	x	x
	PW	x	x	x	x	x	x	x	x

Shunt Configuration - Choice 1



DIALING CHOICE 2:

This choice enables dial-out to Phone #1 for alarm 1 only. Phone #2-8 will be called for alarms 2-4, Temp Low, Temp High, and power failure. To program dialing choice 2, move shunt on pin #7 to the off position. Move shunt on pin #8 to the on position.

Dialout Chart - Choice 2

		PHONE # 1 - 8							
		1	2	3	4	5	6	7	8
INPUTS	01	x							
	02		x	x	x	x	x	x	x
	03		x	x	x	x	x	x	x
	04		x	x	x	x	x	x	x
	TL		x	x	x	x	x	x	x
	TH		x	x	x	x	x	x	x
	PW		x	x	x	x	x	x	x

Shunt Configuration - Choice 2

Shunt #7:

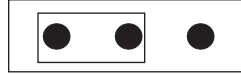

Shunt #8:



DIALING CHOICE 3:

This choice enables dial-out to Phone #1 for Temp Low and Temp High alarms only. Phone #2-8 will be called for alarms 1-4 and power failure. To program dialing choice 3, move shunt on pin #7 to the on position. Move shunt on pin #8 to the off position.

Dialout Chart - Choice 3

		PHONE # 1 - 8							
		1	2	3	4	5	6	7	8
INPUTS	01		x	x	x	x	x	x	x
	02		x	x	x	x	x	x	x
	03		x	x	x	x	x	x	x
	04		x	x	x	x	x	x	x
	TL	x							
	TH	x							
	PW		x	x	x	x	x	x	x

Shunt Configuration - Choice 3

Shunt #7:

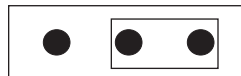

Shunt #8:

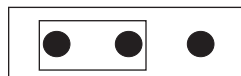

DIALING CHOICE 4:

This choice enables dial-out to Phone #1 for a power failure alarm only. Phone #2-8 will be called for alarms 1-4, Temp Low and Temp High. To program dialing choice 4, move the shunts on pins #7 and #8 to the on position.

Dialout Chart - Choice 4

		PHONE # 1 - 8							
		1	2	3	4	5	6	7	8
INPUTS	01		x	x	x	x	x	x	x
	02		x	x	x	x	x	x	x
	03		x	x	x	x	x	x	x
	04		x	x	x	x	x	x	x
	TL		x	x	x	x	x	x	x
	TH		x	x	x	x	x	x	x
	PW	x							

Shunt Configuration - Choice 4



CHAPTER 7: THE OUTPUT

Express has one relay output that can be controlled automatically or manually. Pin #6, located to the right of the ON/OFF switch on the circuit board, is used to determine how the output will be controlled. See Chapter 6 for more information on Pin #6.

AUTOMATIC CONTROL

For automatic control, Express will switch on the device wired to the relay output whenever an alarm occurs on any of the inputs. When the alarm is acknowledged (**NOT when the condition is corrected**), the output is switched off.

To have the output controlled automatically, you must position the shunt on pin #6 to the left (**OFF** position).

MANUAL CONTROL

You may manually control the output from the local keyboard, or remotely by touch-tone phone. To allow the output to be controlled manually, you must position Shunt #6 to the right (**ON** position).

To switch the output locally:

1. Press the SENSOR ON/OFF key
2. Press the OUTPUT key

Express will say either *"On"* or *"Off."* Repeat the steps to change.

To switch the output remotely:

You must use the phone commands to manually switch the output remotely. To do this, call into Express using a touch-tone phone. First, you will receive a status report. After the listen-in time, Express will say *"OK."* Press ANY KEY on the touch-tone keypad within 10 seconds to access the phone command mode. If this is done, Express will say *"OK"* again. You now have 30

seconds to enter a key command before Express will hang up. If you do not press a key within 30 seconds, Express will say "Have a good day," and disconnect.

1. To turn the output on, press O (number 6), then N (number 6). Express will say "On."
2. To turn the output off, press O (number 6), then F (number 3). Express will say "Off."

If Pin #6 is set in the off position for automatic control, Express will say "Error" if you try to turn the output on or off manually.

For more information on other phone commands, see *Chapter 5*.

POWER LIMITATIONS

Express has two power supplies (5V & 12V) available to power your external sensors or output devices. The maximum current available is 100mA total. This means that the sum of the currents from each supply cannot exceed 100mA.

Maximum switching capacity of the relay output:

2A at 120VAC

2A at 30VDC

EXAMPLE WIRING

12V device using Express power:

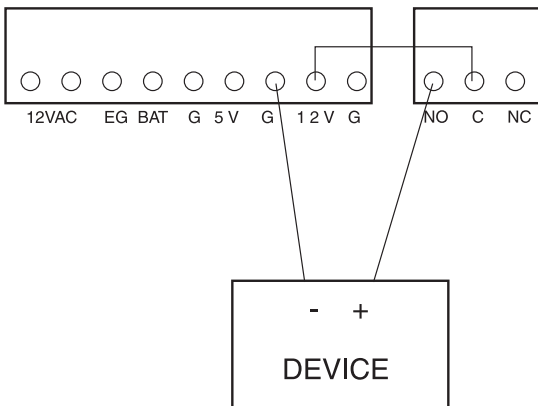

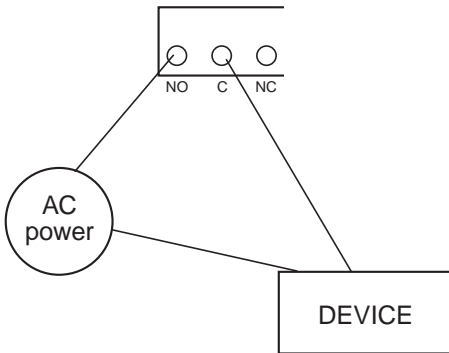
110VAC device using external power source:**POSSIBLE APPLICATIONS**

Automatic Control—If you want to warn on-site personnel that an alarm is occurring, you can wire a horn or buzzer device to Express. In this instance, the output would be best controlled automatically so that whenever an alarm occurred Express would switch the horn on. When the alarm is acknowledged, the horn would be automatically switched off.

Manual Control—You may have a backup generator wired to Express's relay output that you would only want to switch on during a power failure (instead of any alarm). In this instance, you would have the output manually controlled so that when you received an alarm call that a power failure is occurring, you can call Express back and switch the output on. When the power is restored, you can call Express again and switch the generator off.

CHAPTER 8: PROGRAMMING SUMMARY

This section is intended to help you understand the commands and organize your programming. It is advisable to disable the inputs while programming to avoid a dialout if you accidentally trip an alarm. Remember to enable the inputs after programming has been completed. The following is a summary of the possible programming commands. Refer to the programming chapters—3 and 4—for explanation on how to use each command.

MONITORING FUNCTIONS

- 1. Disable inputs 1-4.** This action will allow you to wire and set the dry contact inputs without tripping an alarm dialout.
- 2. Wire inputs 1-4.**
- 3. Configure inputs as normally opened or normally closed.** This command determines what will be the normal or alarm status for each input 1-4. When you set the ID number, the present open/closed state of your sensors will be considered *normal*. For example, if you have input 1 wired as a closed input, setting the ID number will make it normally closed. If the input should be opened, an alarm will result.
- 4. Set input recognition time.** This command determines the length of time an alarm condition must exist before it is considered an alarm. It helps you to minimize alarm dialouts for momentary and/or self-correcting alert incidents. For example, input 1 monitors fluid depth in a brewing vat. Liquid is periodically poured into and drained from the vat. This action causes the liquid to splash above the high fluid mark, resulting in an alarm. However, the fluid quickly settles, just as personnel arrive at the site to siphon the dangerous excess. Setting the recognition time for input 1 to 5 minutes would allow the liquid to stabilize, preventing a false alarm.

- 5. Enable inputs 1-4.** The inputs are now operational and monitoring chosen conditions.
- 6. Disable temperature inputs.** This will allow you to determine Fahrenheit/Celsius, set limits and recognition times without causing an alarm dialout.
- 7. Determine temperature scale.** Express has the capability to monitor in Fahrenheit or Celsius. You should determine the temperature scale before setting limits so that the temperature readings will make sense in your application.
- 8. Set low and high temperature limits.** The range of these limits depends directly on the temperature scale you chose (°F or °C) and the type of thermistor wired (2.8K or 10K).

With the 2.8K thermistor (included) the range is:

-60°F to 175°F
-50°C to 80°C

With a 10K thermistor (optional) the maximum* range is:

-60°F to 300°F
-50°C to 150°C

***Note:** The range may be less depending on the sensor used. It is extremely important to choose the appropriate temperature scale for your application and to properly configure the thermistor before setting limits. Meaningless temperature readings and alarms will result otherwise.

- 9. Temperature recognition times.** This command determines the length of time a low or high temperature condition must exist before Express recognizes it as an alarm. This will prevent dialouts from occurring for momentary and/or self-correcting temperature alerts.
- 10. Enable temperature inputs.** Express is now temperature operational.
- 11. Enable or disable AC power monitoring.** Express is capable of monitoring AC power failure. This feature is built-in, no external wiring is required. You can enable or disable the power

detection. When enabled, Express will dial out for a power failure. When disabled, Express will not dial out if a power failure occurs. The default for this parameter is ENABLED.

12. Power recognition time. This is the length of time a power failure condition must exist before Express considers it an alarm. This feature helps eliminate dialouts during power blips or minor brownouts.

COMMUNICATIONS FUNCTIONS

Express is now prepared for alarm monitoring. Next, you must program your alarm voice messages, Phone numbers, and related dialing specifications.

1. Voice messages. Express's unique digital speech technology allows you to record your own voice for the 4 input alarm messages and an ID message. You have 8 seconds per message for each of the 4 input messages, and 10.5 seconds for the ID message. You can rerecord your messages as often as you wish. Messages may also be recorded remotely over a touch-tone phone. Messages are stored in nonvolatile memory to prevent loss during a power failure or storage.

When recording, speak clearly. This is important locally and remotely. Hold the microphone about 6 inches from your mouth. You may have to experiment to see what voice level records best for you.

2. Dialout telephone numbers. Express can dial up to eight 32-digit phone numbers. These phone numbers are dialed sequentially, so program the first number you want called as Phone #1, the second as Phone #2, etc.

You can also incorporate a pause, pound, or asterisk into the phone number for special dialing circumstances. For example, Express has the capability to call out to a beeper. The desired result when calling a beeper is: 1) Express dials the phone number, 2) a beeper service will answer, 3) the service will look for digits to send to the beeper.

- 3. Tone or pulse dialing.** Express' phone numbers can be dialed out in either touch-tones or pulse depending on your line service. This parameter programs all 8 Phone numbers as tone or pulse. The default is TONE.
- 4. Rings until answer.** This parameter determines how many times Express will allow the phone to ring before answering. For example, if you set this to 4, Express will wait 4 rings and then answer. This feature is also used in conjunction with the Telephone Answering Device (TAD) compatibility.
- 5. TAD compatibility.** Express can operate on the same phone line as other telephone answering devices such as a modem or answering machine. To use this feature, program Express rings until answer to a larger number than the other answering device's rings. For example, Express and an answering machine are on the same phone line. You program the answering machine to answer on the 3rd ring. Set Express to answer on the 5th ring. When you call Express to obtain a status report, you will want to bypass the answering machine. To do this, allow the phone to ring once, hang up, and call again. On the second call Express will override the answering machine by answering on the first ring.
- 6. Call delay time.** This is the amount of time Express will wait after an alarm is recognized before it starts the dialout sequence. NOTE: This feature is different from the input recognition times. Recognition time is the amount of time Express waits to declare an alarm. Call delay is the amount of time Express waits to start the dialout for a declared alarm.
- 7. Intercall time.** After the initial phone call, this is the amount of time Express will wait between calls before dialing the next number. For example, you set the intercall time to 2 minutes. When an alarm occurs and Phone #1 has been called, Express will wait 2 minutes after hanging up with Phone #1 before calling Phone #2.
- 8. Voice repetitions.** This parameter determines how many times Express will repeat the alarm message when it dials out.

For example, if you have this feature set to 5, Express will repeat its message 5 times before requesting acknowledgment when an alarm dialout is answered.

9. Max calls. The maximum number of calls Express will dial if none of the calls are acknowledged is determined by this feature. If the number of calls reaches the max calls value, Express will automatically acknowledge the alarm and the dialout will be stopped. Of course, when a call is acknowledged the dialout sequence is automatically stopped.

NOTE: If only one Phone Number is programmed, Express will dial a maximum of 15 times, regardless of the value of max calls.

10. Listen-in time. Express allows you to listen in to sounds at the monitor site through its microphone when you call in for a status report. This parameter allows you to determine the amount of time for sound monitoring.

11. Local mute. This parameter allows you to mute the local voice when Express dials out for an alarm. When the mute is on, the dialout alarm message will not be heard at the monitor site. When the mute is off, Express will repeat the message locally as well as over the phone.

USER OPTIONS

There are two other features available to further control and customize the dialout sequence: Redial on Busy and Dialing Pattern. These two features are enabled by configuring PIN #4, PIN #7 and PIN #8 on the circuit board.

Redial on Busy. This feature enables Express to redial a phone number that is busy. Redial on Busy is determined by PIN #4 on the circuit board. Depending on the position of the shunt, Express will either proceed to the next phone number when it encounters a busy signal, or it will wait 10 seconds and dial the phone number again. If on the second try the number is still busy, Express will proceed to the next phone number.

Dialing Pattern. This feature allows you to organize your dialout sequence so that Phone #1 will be called for specific input alarms rather than all input alarms. There are four dialing choices that are governed by the positions of PIN #7 and PIN #8 located to the right of the ON/OFF switch on the Express circuit board. This option is useful if you want Phone #1 to have Express dial out to a municipal service, such as the fire company. In this instance, you would only want it called for a fire alarm. You would configure input 1 to monitor fire/smoke. Program in the fire company phone number as Phone #1. Configure the priority calling pins #7 and #8 to the dialing choice #2. Now an alarm on input 1 will only call Phone #1. All other input alarms will call the remaining 7 Phone numbers.

CHAPTER 9: EXPRESS EXAMPLES

This section is provided to illustrate how Express operates. An example programming strategy is outlined below. The communications programming, monitoring setup and pin configurations are charted to give you a reference for the sample Express. Next, possible alarm situations that you may encounter are given to explain the process by which Express will respond. This section does not provide all the possible circumstances that may happen, but it will give you an understanding of how the many features of Express interplay to create a comprehensive monitoring package. Refer to Chapters 3, 4 and 5 for how to program Express. See Chapter 8 for a summary of each parameter and examples of how they are used.

The following is a quick outline of the alarm situations discussed in this chapter. Refer to the corresponding heading for further details:

EXAMPLE 1:

An alarm on input 1 demonstrates the dialing pattern and touch-tone acknowledgment.

EXAMPLE 2:

An alarm on input 2 illustrates the function of the alarm recognition time.

EXAMPLE 3:

An alarm on input 3 demonstrates the redial on busy feature and callback acknowledgment.

EXAMPLE 4:

An alarm on input 4 explains what happens when an input has been disabled.

EXAMPLE 5:

A low temperature alarm demonstrates the dialout sequence and callback acknowledgment.

EXAMPLE 6:

A high temperature alarm illustrates the max calls parameter.

EXAMPLE 7:

A power alarm explains on-site acknowledgment.

SAMPLE STRATEGY

Below is a sample Express setup. This setup will be used and referred to in explaining how Express operates according to its programming.

COMMUNICATIONS PARAMETERS

Voice Messages:

Location ID message: "This is the equipment room located in Building One North."

Input alarm message 1: "Water tank level exceeds acceptable limits."

Input alarm message 2: "Boiler 3 pressure has surpassed the safe limits."

Input alarm message 3: "Smoke has been detected. Fire emergency possible."

Input alarm message 4: "Motion sensors have detected an intruder on the premises."

Dial-out Telephone Numbers:

Phone 1: 555-1111

Phone 2: 555-1222

Phone 3: 555-1233

Phone 4: 555-1234

Phone 5: 1-215-555-4555

Phone 6: 1-609-555-4566

Phone 7: 555-4567

Phone 8: 555-7888

TONE Dialing: ON
Rings Until Answer: 5
Call Delay Time: 150 seconds (2 min. 30 sec.)
Intercall Delay Time: 3 minutes 0 seconds
Voice Repetitions: 4
Max Calls: 50
Listen-in Time: 10 seconds
Security Code: 2327
Callback Acknowledgment (Pin #2): ON
Security Bypass (Pin #3): OFF
Redial on Busy (Pin #4): ON
Dialing Pattern (Pins #7 & #8): Dialout Option #1
ID #: 555-3833

MONITORING PARAMETERS

input	enabled/disabled	open/closed	rec. time	condition
Input 1:	Enabled	N/O	2 min	Tank water level
Input 2:	Enabled	N/O	30 sec	Pressure
Input 3:	Enabled	N/O	30 sec	Smoke/fire
Input 4:	Disabled	N/C	1 min	Intrusion
Low Temp:	Enabled		10 min	Low limit: 60°F
High Temp:	Enabled		10 min	High limit: 70°F
AC Power:	Enabled		30 min	Power failure

EXPRESS EXAMPLES

The following section presents hypothetical alarm situations for each of the inputs and illustrates the sequence of steps Express will take depending on its programming.

EXAMPLE 1

Alarm Recognition:

The water level in Tank 1 has exceeded acceptable limits. The normally open sensor has closed causing an alarm. This condition has existed longer than 2 minutes (recognition time for input 1) and Express has recognized the condition as a valid

alarm. The red LED for input 1 on the Express face plate is lit and blinking to indicate to on-site personnel that an alarm condition exists and has not been acknowledged.

Dialout:

1. After 2 minutes 30 seconds (call delay time), Express will begin the alarm dial-out sequence.
2. Express dials Phone #1 and receives no answer.
3. Express hangs up. This will count as one call toward the max calls total of 50.
4. Express waits 3 minutes (the intercall time) and dials Phone #2. Again, Express receives no answer and hangs up.
5. Express waits 3 minutes and dials Phone #3. The call is answered.
6. Express recites the following dialout alarm message:

“Hello, this is 555-3833. This is the equipment room located in Building One North. Water tank level exceeds acceptable limits.”

The dialout message is repeated four times. At the end of the fourth repetition, Express will request acknowledgment of the alarm.

“Please acknowledge.”

Acknowledgment:

1. The receiver is at a touch-tone phone; she enters the code “555” within 10 seconds to acknowledge the alarm.
2. Express says: *“OK. Have a good day,”* and hangs up. The alarm is acknowledged.

Once the alarm is acknowledged, the dialout sequence is stopped. The red LED will glow steadily but not blink as long as the condition still exists. The max calls counter is reset to zero.

EXAMPLE 2

Alarm recognition:

The pressure in boiler 3 has suddenly exceeded safe levels. Input 2 is wired to monitor the pressure in boiler 3. The N/O sensor closes to indicate the alarm. In response, a pressure-sensitive

valve opens. This self-correcting mechanism reduces the pressure to acceptable levels within 15 seconds. The alarm recognition time for input 2 is 30 seconds. Because the alarm condition did not exist for 30 seconds, Express did not recognize the situation as a valid alarm. No dialout occurred.

NOTE: For the remaining examples, the Dialing Pattern has been changed to illustrate an alternate dialing choice. Dialing Choice #2 enables the alarm dialout to Phone #1 for an alarm on input 1 only. Phone # 2-8 will be called for alarms 2-4, Low Temp, High Temp and power failure.

EXAMPLE 3

Alarm recognition:

A frayed wire sparks and sets off a small fire and smoke begins to fill the room. Input 3 detects smoke and the sensor closes. After the 30 second recognition time, Express recognizes the condition as a valid alarm. The red LED for Input 3 will be lit and blinking. After the 2 minute, 30 second call delay time, Express begins the alarm dialout.

Dialout:

1. The first number Express dials is Phone #2 (555-1222). This is because Phone #1 is reserved for alarms on input 1. There is no answer at Phone #2.
2. Express hangs up and waits 3 minutes.
3. Express then dials Phone #3 and receives a busy signal.
4. Express hangs up, waits 10 seconds and dials Phone #3 again (the redial on busy option is on).
5. This time the call is answered. The following message is repeated four times:

“Hello, this is 555-3833. This is the equipment room located in Building One North. Smoke has been detected. Fire emergency possible.”

Acknowledgment:

The receiving phone is pulse (rotary) dial. After the message has been repeated, Express requests acknowledgment:

“Please acknowledge.”

Since Phone #3 is a pulse phone, it is not possible for the receiver to enter the acknowledgment code. However, the callback acknowledgment feature is set to on so the receiver can call the unit back to acknowledge that the alarm message was received. Because the code was not entered within 10 seconds, Express says, *“Have a good day.”*

To acknowledge the alarm, the receiver must call back the unit.

1. Dial the unit phone number: 555-3833.
2. Express recites the dialout alarm message.
3. Simply stay on the line. After 10 seconds, Express will say, *“Alarm OK. Have a good day.”* This indicates that the alarm has been acknowledged.

The dialout sequence has been stopped. The red LED will glow steadily until the alarm condition has been resolved.

EXAMPLE 4

Alarm recognition:

A suspicious character enters through the side door monitored by a sensor wired to input 4. The normally closed sensor is thus opened, tripping the sensor. However, input 4 has been disabled therefore, no alarm dialout will occur. The red LED will turn on after the one minute recognition time. It will glow steadily (no blinking) until the alarm condition has been resolved.

EXAMPLE 5

Alarm recognition:

The tropical fish aquarium temperature has dropped below 60°F, and is still falling. The tank heater has malfunctioned. Low tank temperature is monitored on the temperature input. This condition has existed for 10 minutes (recognition time) and the fish are beginning to shiver. Express recognizes the condition as an alarm. The red LED for low temp is blinking to alert on-site personnel.

Dialout:

1. After the 2 minute, 30 second call delay, Express begins the alarm dialout sequence.
2. Since this unit is programmed for Dialing Choice #2, the first Phone number Express calls for a low temperature alarm is Phone #2.
3. It receives no answer and hangs up.
4. After the 3 minute intercall time, Express dials Phone #3. Again, no answer.
5. After 3 minutes, it dials Phone #4. Still receiving no answer, Express hangs up, waits 3 minutes and dials Phone #5, then Phone #6, Phone #7, and Phone #8—waiting the intercall time between each call. (Total calls = 7)
6. Express calls Phone #2 again. This time, the call is answered.
7. Express recites the following alarm message four times:
“Hello, this is 555-3833. This is the equipment room located in Building One North. The temperature is low. The temperature is 54 degrees.”

After the last repetition, Express will request acknowledgment:

“Please acknowledge.”

Acknowledgment:

The receiver did not enter the acknowledgment code within the 10-second time requirement. Express says:

“Have a good day.”

1. Express then hangs up. The receiver did not call the unit to acknowledge the alarm.
2. Express waits 3 minutes (intercall time), and calls Phone #3.
3. The call is answered. Express recites the above alarm message and requests acknowledgment.
4. Because the receiver is at a pulse phone, he cannot enter the acknowledgment code,
5. However, after Express has hung up, he calls the unit back, thus acknowledging the alarm.

The dialout sequence has been stopped. The red LED for low

temp stops blinking and glows steadily until the condition is corrected.

EXAMPLE 6

Alarm recognition:

Now the heater is back on in the fish aquarium. Unfortunately, it has gone haywire. The water temperature has risen above 70°F and the fish are hopping. After 10 minutes, this condition still exists. Express recognizes it as a valid alarm. The red LED for high temp is on and blinking. After the 2 minute 30 second call delay time, Express begins the dialout sequence.

Dialout:

1. Express dials out to Phone #2 and receives no answer.
2. The unit waits the 3 minute intercall time and then dials Phone #3. No answer.
3. The unit waits 3 minutes and then dials Phone #4. The call is answered by an answering machine.
4. Express recites the following message:
“Hello, this is 555-3833. This is the equipment room located in Building One North. The temperature is high. The temperature is 73 degrees.”

Express repeats this message four times and then requests acknowledgment.

“Please acknowledge.”

Acknowledgment:

Since the receiver is an answering machine, it cannot enter the acknowledgment code. After 10 seconds, Express says “Have a good day.”

1. Express waits the 3 minute intercall time and then dials Phone #5. (Total calls = 4)
2. The unit receives no answer, hangs up, waits 3 minutes and dials Phone #6. The phone is busy.
3. Express hangs up and dials Phone #6 again (The dialback option is on). The line is still busy.

4. Express hangs up, waits 3 minutes and dials Phone #7.

Express does not receive an answer from any of the Phone numbers. There was no callback acknowledgment. After 50 phone calls (max calls), Express automatically acknowledges the alarm and stops the dialout sequence. The red LED will remain on as long as the alarm condition still exists.

EXAMPLE 7

Alarm recognition:

The building power blacked out at 7:25AM. At 7:55AM, the power is still out, and Express recognizes the failure as an alarm (30-minute recognition time).

Dialout:

1. After the 2-minute 30-second call delay time, Express begins the dialout to Phone #2.
2. The call is not answered, so Express hangs up.
3. After the 3-minute intercall time, the unit dials Phone #3 and again receives no answer.
4. In the meantime, the plant manager arrives at the building at 8AM. She discovers the power failure and checks Express to see if the dialout sequence has been started and if the alarm has been acknowledged.

Acknowledgment:

The manager sees that the alarm has been recognized (because it existed beyond 30 minutes), and that it has not yet been acknowledged (the red LED is still blinking). She presses the alarm cancel key to acknowledge the alarm. Express says: "OK." The dialout sequence has been stopped. The red LED will glow steadily until the condition is resolved or the battery backup is exhausted.

CHAPTER 10: TROUBLESHOOTING

Problems with the Express can range from simply making sure the unit is plugged in, to lightning damage. This chapter is provided to help you pinpoint and solve functioning problems. It is divided into the common areas where problems occur. They are:

- Communications / Dialout problems
- Incorrect temperature readings
- Monitoring problems

If the unit still does not work after you have tried the following solutions, call our Technical Service Department at 610.558.2700 or follow the guidelines for sending the unit in for repair.

Problem	Possible Cause	Solution
Communications / Dialout:		
Unit won't dial out	Phone number incorrectly programmed	See Chapter 3.
	Incorrect tone/pulse selection	See Chapter 3.
	Incompatible phone line	Express must be hooked up to a standard 2-wire analog phone line, NOT a digital extension to a phone system. If the unit won't dial out and it is not the two previous problems, try hooking the unit up to a phone line that you know is standard (such as a residential or home phone). If it works, then there is an incompatibility with the other phone system. If this does not work, call Phonetics' Technical Service Department.
Unit won't answer phone	Incorrect programming of rings until answer	When used on a proper extension line, some phone systems won't let the phone ring past 4 rings. If rings until answer is greater than 4, you cannot get to the unit. Try setting the rings to less than 4 (see Chapter 3). If it still does not work, then the phone line may be incompatible. See below.
	Incompatible phone line	Express must be hooked up to a standard 2-wired analog phone line, NOT a digital extension to a phone system. If you cannot call into the unit, try hooking it up to a phone line that you know is standard (such as a residential or home phone). If you can call in, then there is an incompatibility with the other phone system. If you still cannot call in, call Phonetics' Technical Service Department.

Problem	Possible Cause	Solution
----------------	-----------------------	-----------------

Incorrect temperature readings:

Temperature reads -60°	Temperature sensor is either disconnected or has broken wires	Check wires to temperature sensor and connect or replace wiring.
Temperature reads 175°	Temperature sensor wires touching	Verify and correct wiring.
Temperature inaccurate	The temperature sensing may be affected by ambient heat source (i.e.. direct sunlight, heating vent)	Move the temperature sensor to a different location.
	Incorrect Fahrenheit/Celsius selection	See Chapter 4.

Monitoring Problems:

Alarm status of alert input incorrect	Incorrect input normality	Reset input normality. See Chapter 4.
False power out alarms	Power recognition time too short	It is common for the power to have brief interruptions. To solve a false alarm, program the power recognition time longer.
Unit does not recognize any alarms.	Inputs disabled for alarm	Enable the inputs for alarm. See Chapter 4.

APPENDIX A: CHECKING YOUR SENSAPHONE FOR PROPER OPERATION

We recommend that you test your Sensaphone weekly to be sure it is functioning properly. This will ensure that when a problem arises the Sensaphone will be ready to alert the appropriate personnel.

There are several tests that can be performed:

- 1) Call the unit and listen to the Status Report. This will test the unit's ability to answer the phone and speak a message. It will also verify that all of the inputs are reading properly, the alarm conditions are OK, the electricity is on and the microphone is functioning.
- 2) Create an alarm on each input and allow the unit to contact all programmed telephone numbers. This will ensure that the Sensaphone is programmed properly. It will also prepare personnel to respond appropriately when they receive a call from the Sensaphone.
- 3) Test the battery by unplugging the AC adapter and making sure that the Sensaphone continues to function. Press WHAT IS, then STATUS on the keypad, and listen to the status report. Make sure the report states that "the electricity is off." Check the "Battery OK" LED and make sure it is on steady. Keep the AC adapter unplugged so that a Power Failure alarm occurs. Allow the unit to dial all programmed telephone numbers while running on battery backup. Plug in the AC adapter after the unit has finished dialing all of the telephone numbers.

APPENDIX B: ACCESSORIES

The sensors listed are the most commonly used input devices. However, there is a virtually unlimited variety of sensor/switch input devices available at commercial or industrial electrical supply houses. They can provide a device to monitor virtually any condition that might be required for your business, industrial or residential needs. Contact PHONETICS, INC. at 610-558-2700 for more information.

MODEL NUMBER	SENSOR/ SWITCH
FGD-0006	Magnetic Reed Switch
FGD-0007	Passive Infrared Detector
FGD-0010	50' two-conductor #22AWG shielded Accessory Cable
FGD-0013	Spot Water Detector
FGD-0022	Temp Alert
FGD-0023	ISOTEL Surge Protector
FGD-0027	Humidistat
FGD-0049	Smoke Detector w/Built-in Relay
FGD-0054	Power-Out Alert™
FGD-0056	Zone Water Detector w/Water Rope
FGD-0063	10' additional Water Rope for FGD-0056
FGD-0100	2.8K Remote Temperature Sensor
FGD-0101	2.8K Weatherproof Temperature Probe
FGD-0102	10K Weatherproof Temperature Probe
FGD-0103	10K Indoor Zone Temperature Sensor
FGD-0104	10K Outdoor Air Temperature Sensor
FGD-0105	10K Immersion Temperature Sensor
FGD-0200	Phonecell SX3e Cellular Phone

APPENDIX C: 10K THERMISTOR LOOK-UP TABLE

DEGREES (Celsius)	DEGREES (Fahrenheit)	RESISTANCE (Ohms)
-37	-35	203.60K
-35	-30	173.60K
-32	-25	148.30K
-29	-20	127.10K
-26	-15	109.20K
-23	-10	94.07K
-21	-5	81.23K
-18	0	70.32K
-15	5	61.02K
-12	10	53.07K
-9	15	46.27K
-6	20	40.42K
-4	25	35.39K
-1	30	31.06K
2	35	27.31K
4	40	24.06K
7	45	21.24K
10	50	18.79K
13	55	16.65K
16	60	14.78K
18	65	13.15K
21	70	11.72K
24	75	10.46K
27	80	9.35K
30	85	8.38K
32	90	7.52K
35	95	6.75K
38	100	6.08K
41	105	5.48K
44	110	4.95K
47	115	4.47K
49	120	4.05K
52	125	3.67K
55	130	3.33K
58	135	3.31K
60	140	2.76K
63	145	2.52K
66	150	2.30K
69	155	2.10K
71	160	1.92K
74	165	1.76K
77	170	1.61K
80	175	1.48K
83	180	1.36K
86	185	1.25K
88	190	1.16K
91	195	1.07K
94	200	0.98K
97	205	0.91K

APPENDIX D: RETURNING UNITS FOR REPAIR

In the event that Express does not function properly and you cannot reprogram it, we suggest that you do the following:

- 1) Carefully write down your observations of Express's malfunctioning.
- 2) Call Phonetics Technical Service at 610-558-2700 if any instructions are not clear or if you have any questions.

If the unit must be sent to us for servicing, do the following:

- 1) Turn the power switch off, unplug the AC power supply from the wall outlet, and disconnect all sensors from the alert inputs.
- 2) Carefully pack unit into its original container or a sturdy shipping box. Be certain to use sufficient cushioning material to avoid damage in transit.
- 3) Address package to:

SERVICE DEPARTMENT
PHONETICS, INC.
901 TRYENS ROAD
ASTON, PA 19014

- 4) Ship prepaid and insured via UPS or US Mail to ensure a traceable shipment with recourse for damage or replacement.
- 5) To avoid processing delays, be sure to include the following:
 - a) Your name, address, and phone number
 - b) Model and Serial numbers
 - c) A letter explaining Express's problem